

ATTENTIONAL MODULATION OF VISUAL PROCESSING

John H. Reynolds¹ and Leonardo Chelazzi²

¹*Systems Neurobiology Laboratory, The Salk Institute for Biological Studies, La Jolla, California 92037-1099; email: reynolds@salk.edu*

²*Department of Neurological and Vision Sciences, Section of Physiology, University of Verona, Strada Le Grazie 8, I-37134 Verona, Italy; email: leonardo.chelazzi@univr.it*

Key Words macaque, visual cortex, contrast, feedback, limited capacity

■ **Abstract** Single-unit recording studies in the macaque have carefully documented the modulatory effects of attention on the response properties of visual cortical neurons. Attention produces qualitatively different effects on firing rate, depending on whether a stimulus appears alone or accompanied by distracters. Studies of contrast gain control in anesthetized mammals have found parallel patterns of results when the luminance contrast of a stimulus increases. This finding suggests that attention has co-opted the circuits that mediate contrast gain control and that it operates by increasing the effective contrast of the attended stimulus. Consistent with this idea, microstimulation of the frontal eye fields, one of several areas that control the allocation of spatial attention, induces spatially local increases in sensitivity both at the behavioral level and among neurons in area V4, where endogenously generated attention increases contrast sensitivity. Studies in the slice have begun to explain how modulatory signals might cause such increases in sensitivity.

INTRODUCTION

The central role of attention in perception has been known since the dawn of experimental psychology (James 1890). The advent of new techniques for imaging the human brain complement earlier studies of brain-lesioned patients, enabling neuroscientists to map out the set of areas that mediate the allocation of attention in the human (for recent reviews, see Corbetta & Shulman 2002, Yantis & Serences 2003) and to examine how feedback from these areas alters neural activity in the visual cortices (reviewed by Chun & Marois 2002, Kastner & Ungerleider 2000). The development of techniques to record the activity of neurons in awake behaving animals has enabled researchers to probe the biological underpinnings of attention. In this review, we outline recent progress in understanding the circuits within the visual cortex that are modulated by attentional feedback.

Single-unit recording studies in the monkey have provided detailed, quantitative descriptions of how attention alters visual cortical neuron responses. When attention is directed to a location inside the receptive field (RF), the neuron's contrast-response threshold is reduced, enabling it to respond to stimuli that would otherwise be too faint to elicit a response. For stimuli presented at intermediate contrasts, spatial attention increases the firing rate by a multiplicative factor that is independent of the neuron's tuning for such properties as orientation and direction of motion. This scaling of the response enables neurons to discriminate more reliably the features of the attended stimulus. For stimuli presented at contrasts that exceed the neuron's contrast saturation point, attention has little or no effect on firing rate. Attention has qualitatively different effects when it is directed to one of two stimuli appearing simultaneously inside the receptive field. Both increases and decreases are observed, depending on the neuron's selectivity for the two stimuli. When one of the two stimuli is placed in the receptive field and the other in the surround, attending to the extrareceptive field stimulus can reduce the firing rate. All these phenomena can be accounted for by models developed to explain contrast-dependent modulations of neuronal response if one assumes that attending to a spatial location increases the effective contrast of stimuli appearing there. These attention-dependent modulations of responses in the visual cortex occur as a result of feedback from areas like the lateral intraparietal area (LIP), where elevated responses are associated with increased contrast sensitivity at the behavioral level, and the frontal eye fields (FEF), where microstimulation causes spatially localized increases in sensitivity both at the behavioral level and in visual cortical neurons. Recent studies in the slice have begun to characterize how modulatory signals can change neuronal responsiveness. A similar explanation may account for the effects of feature-based attention, if one assumes that attending to a feature increases sensitivity of neurons selective for that feature. Thus, attention-dependent improvements in our ability to detect faint stimuli, to discriminate stimulus features, and to select a stimulus from among distracters can all be understood as reflecting the operation of a relatively simple set of neural mechanisms.

SPATIAL ATTENTION: FACILITATION AND SELECTION

Psychophysical studies, event-related-potential studies, and brain-imaging studies of spatial attention in humans carefully document the phenomenon of attentional facilitation, the improved processing of a single stimulus appearing alone at an attended location (Posner et al. 1980). Observers can better detect faint stimuli appearing at an attended location (Bashinski & Bacharach 1980, Handy et al. 1996, Hawkins et al. 1990, Muller & Humphreys 1991) and can better discriminate properties of the attended stimulus, such as its orientation (Downing 1988, Lee et al. 1999). The effect of attending to a faint stimulus can be described as an enhancement of signal strength, as measured by the contrast increment that would be required to equate accuracy in discriminating features of stimuli appearing at an

attended location versus an unattended location (Carrasco et al. 2000, Lu et al. 2000, Lu & Doshier 1998), and there is recent evidence that attention increases perceived stimulus contrast (Carrasco et al. 2004). This signal enhancement is reflected in greater stimulus-evoked neuronal activity, as measured by scalp potentials (e.g., Luck et al. 1994, reviewed by Hillyard & Anllo-Vento 1998), and brain imaging (e.g., Brefczynski & DeYoe 1999, Heinze et al. 1994; see Pessoa et al. 2003, Yantis & Serences 2003 for recent reviews).

Consistent with these observations, single-unit recording studies in monkeys trained to perform attention-demanding tasks have found that spatial attention often enhances neuronal responses evoked by a single stimulus appearing within the receptive field, an effect observed in neurons throughout the visual system (Ito & Gilbert 1999, McAdams & Maunsell 1999a, Motter 1993, Mountcastle et al. 1987, Roelfsema & Spekreijse 2001, Spitzer et al. 1988, Treue & Maunsell 1996). An example of this attention-dependent response facilitation is illustrated in Figure 1, which shows data recorded by Reynolds et al. (2000). The dashed line in

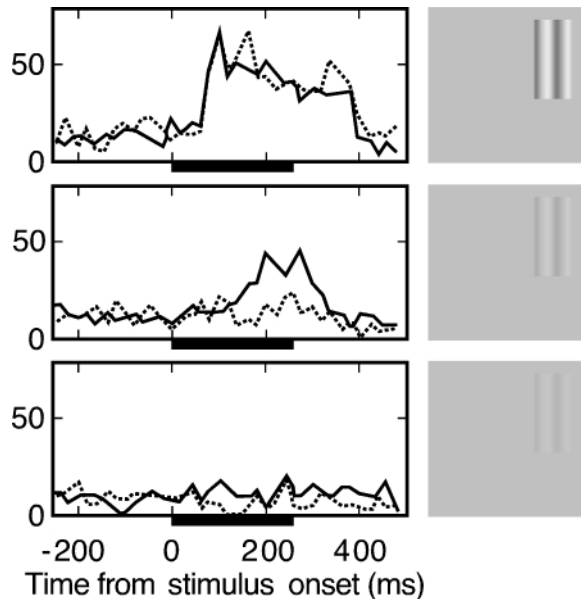

Figure 1 Responses of an example area V4 neuron as a function of attention and stimulus contrast. The contrast of the stimulus in the receptive field varied from 5% (*bottom panel*) to 10% (*middle panel*) to 80% (*upper panel*). On any given trial, attention was directed to either the location of the stimulus inside the receptive field (*solid line*) or a location far away from the receptive field (*dotted line*). The animal's task was to detect a target grating at the attended location. Attention reduced the threshold level of contrast required to elicit a response without causing a measurable change in response at saturation contrast (80%). Adapted from Reynolds et al. (2000).

each panel shows the response elicited by a stimulus that appeared in the receptive field of a V4 neuron while the monkey attended away from the receptive field to detect a target and earn a juice reward. The stimulus appeared at one of three levels of luminance contrast, two of which (5%, bottom panel, and 10%, middle panel) were too faint to elicit a response. That is, they were both below the neuron's contrast-response threshold. The third contrast (80%, top panel) was above the level of contrast at which the neuronal response saturated. The solid line shows the response, under identical sensory conditions, when spatial attention was directed to the stimulus.

Attention had no measurable effect on the response that was elicited at 5% contrast, which was well below the neuron's contrast-response threshold. The 10% contrast stimulus, which was just below the neuron's contrast-response threshold, and thus did not elicit a response when attention was directed away from the receptive field, elicited a clear response when attention was directed to its location in the receptive field. The average response elicited by the 10% contrast stimulus peaked at ~ 35 spikes per second, well above the baseline activity of the neuron. Thus, with attention directed away from the receptive field, the threshold level of contrast required to elicit a response was above 10%, but when attention was directed to the location of the stimulus, the contrast-response threshold was reduced to a value between 5% and 10%. Attention had no measurable effect on the neuronal response elicited by the stimulus when it was presented above saturating contrast.

Although the psychophysical and neurophysiological data clearly show that attention can facilitate processing of single stimuli appearing against a blank background, a more ecologically relevant purpose is served by attentional selection, the selection of behaviorally relevant stimuli from among competing distracters (Duncan & Humphreys 1989, Palmer et al. 2000, Treisman & Gelade 1980, Vergheze 2001, Wolfe et al. 1989). Like any information-processing system, the visual cortex is limited in the quantity of information it can process at each moment in time. A typical visual scene contains a great deal more information than we can process in a single glimpse. Therefore, neural mechanisms must be in place to ensure that behaviorally relevant information will be selected to guide behavior.

Recordings from neurons within the extrastriate cortex have revealed a direct neural correlate of attentional selection. When multiple stimuli appear within a neuron's receptive field, the neuronal response tends to be driven preferentially by the task-relevant stimulus. The first single-unit recording study to document this finding was conducted by Moran & Desimone (1985). Two stimuli appeared within the receptive field: one that was of the neuron's preferred color and orientation, and another that was of a nonpreferred color and orientation. The monkey performed a task that required it to attend to one of the stimuli to report its identity and earn a juice reward. Moran & Desimone found that the neuron's response to the pair was stronger on trials when the monkey attended to the preferred stimulus, as compared to trials when the monkey attended to the nonpreferred stimulus.

A replication of this observation is illustrated in Figure 2, which shows data gathered by Chelazzi et al. (2001). Each line in Panel *B* shows the response averaged across a population of 76 neurons recorded in area V4 of monkeys performing a visual search task. As illustrated in Panel *A* on each trial, a stimulus appeared at fixation and then disappeared for 1500 ms, whereupon the same stimulus that had appeared at fixation (the target) reappeared at a random location in the receptive field, sometimes accompanied by another stimulus, and the monkey had to make a saccade to the target stimulus to earn a juice reward. The two stimuli were selected according to the response selectivity of the neuron. Thus, one (the preferred stimulus) was chosen to be of a shape and color that elicited a strong response, and the other (the poor stimulus) was chosen to elicit a low-firing-rate response.

The upper line in Panel *B* shows the population average response on trials when the preferred stimulus appeared alone as a target. The lowest line shows the average response when the poor stimulus appeared alone as the target. The two middle lines show the response when the pair of stimuli appeared together within the receptive field on trials when the preferred stimulus was the target (upper middle line) and on trials when the poor stimulus was the target (lower middle line). The initial response to the pair was not strongly dependent on which stimulus was the target, but after 150–160 ms, the pair response bifurcated, either increasing or decreasing, depending on whether the target was preferred or poor.

This observation that the attended stimulus exerts preferential control over the neuronal response has been replicated and extended both in the ventral stream areas studied by Moran & Desimone (1985) (Chelazzi et al. 1993, 1998, 2001; Luck et al. 1997; Motter 1993; Reynolds et al. 1999; Reynolds & Desimone 2003; Sheinberg & Logothetis 2001) and in the dorsal stream (Recanzone & Wurtz 2000, Treue & Martínez-Trujillo 1999, Treue & Maunsell 1996; however, see Seidemann & Newsome 1999).

Several of the above studies compared the response elicited by a pair of stimuli in the receptive field when the monkey attended either away from the receptive field or to one of the two stimuli inside the receptive field. These studies have found that attending to the more preferred stimulus increases the response to the pair, but attending to the poor stimulus often reduces the response elicited by the pair (Chelazzi et al. 1998, 2001; Luck et al. 1997; Martínez-Trujillo & Treue 2002; Reynolds et al. 1999; Reynolds & Desimone 2003; Treue & Martínez-Trujillo 1999; Treue & Maunsell 1996). This finding has lent support to models of attention in which inhibition plays a role in selection (Desimone & Duncan 1995, Ferrera & Lisberger 1995, Grossberg & Raizada 2000, Itti & Koch 2000, Lee et al. 1999, Niebur & Koch 1994). These models have accounted for a variety of observations concerning topics as varied as the interplay between attentional selection and oculomotor control, the role of visual salience in guiding attentional selection, and the role of working memory in guiding attention during search. Given the broad explanatory power of such competitive selection models, it is of interest to consider what has been learned from studies in anesthetized animals about the role of response suppression in the visual cortex.

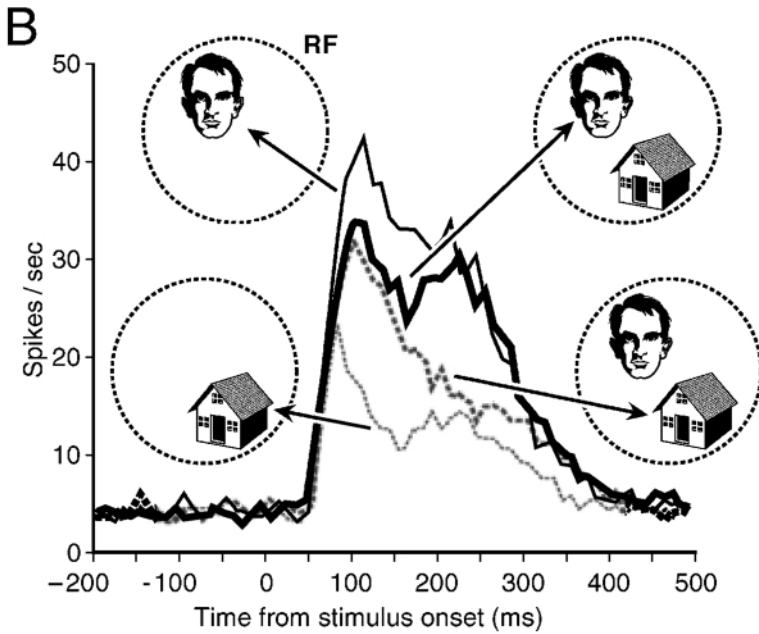
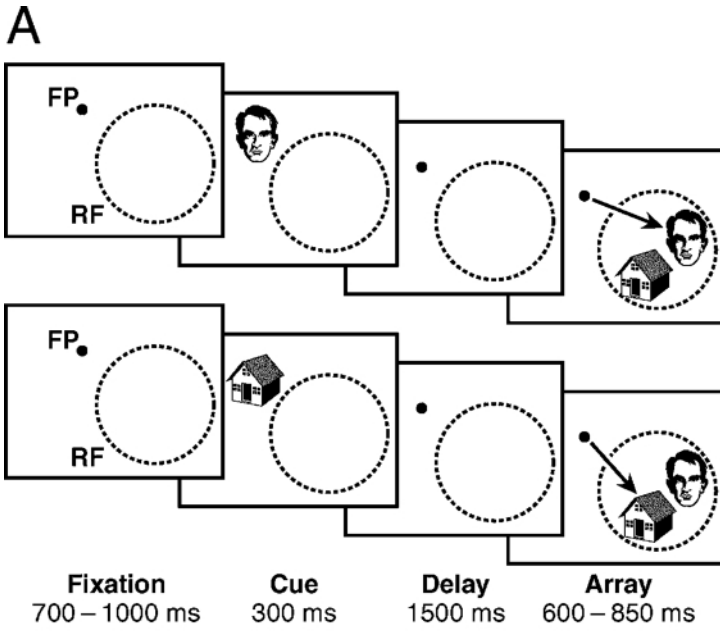

CONTRAST-DEPENDENT RESPONSE MODULATIONS IN ANESTHETIZED ANIMALS PROVIDE CLUES ABOUT THE NEURAL MECHANISMS OF ATTENTION

The role of contrast in modulating the visual response properties of neurons has been extensively documented, and the models developed to account for these modulations rely critically on response suppression. As we will see, the circuitry underlying these modulations can be used to account for the attention-dependent response modulations, mentioned above. Here we describe four ways in which contrast modulates neuronal responses in the anesthetized mammal: Two occur when a single stimulus appears alone within the neuronal receptive field, and two occur when two stimuli appear together, either both within the classical receptive field or one inside the receptive field and the other in the receptive field surround. We then describe models developed to account for these response properties. Finally, we describe a model of attention that is mathematically related to these earlier models and demonstrate that it can therefore account for these contrast-dependent response modulations.

The first phenomenon is that cortical neuronal responses typically saturate as contrast increases, and this saturation firing rate is stimulus dependent. This finding is illustrated in Figure 3A, which is adapted from a study by Sclar & Freeman (1982). Each line shows the response of a complex cell recorded in cat area 17

←

Figure 2 Responses of V4 neurons during a visual search task. (A) Task. The monkey initiated a trial by foveating a spot at the center of the computer monitor (“FP”), after which a sample stimulus appeared nearby (here, either a face on the trial illustrated above or a house on the trial illustrated below). The sample then disappeared for 1500 ms, at which time the search array appeared, and the monkey had to make a saccade to the stimulus that matched the sample (the “target”). (B) Population histogram from 76 V4 neurons recorded during this task. For each neuron studied, the stimuli were selected from a pool of possible stimuli such that one of them (the preferred stimulus—here, the face) elicited a strong response and the other (the poor stimulus—here, the house) elicited a weak response. Responses are time locked to stimulus onset. From bottom left in a clockwise direction, insets illustrate conditions where the poor stimulus alone was presented inside the RF, the preferred stimulus alone was presented, the pair was presented with the preferred stimulus as the target, and finally, the pair was presented with the poor stimulus as the target. In all conditions, the animal made a saccade to the target stimulus, which appeared either alone or as an element of the pair. The initial part of the visual response to the pair falls between the response evoked by the preferred and poor stimuli. At 150–160 ms after display onset, the pair response increased or decreased, depending on which stimulus was the target. By the time of the onset of the saccade, 70–80 ms later, the pair response was driven almost entirely by the attended stimulus. Adapted from Chelazzi et al. (2001).

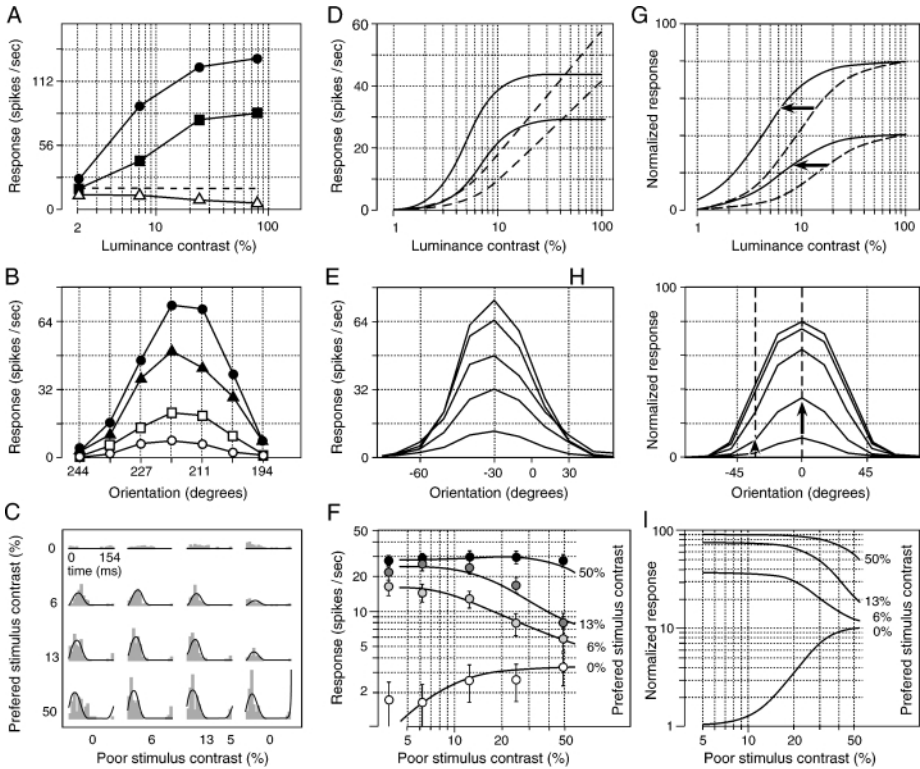

Figure 3 Contrast-dependent response modulations. (A) Contrast-response functions for a stimulus of the neuron’s preferred orientation (*upper line*), a poor but excitatory orientation (*middle line*), and the null orientation (*bottom line*). Adapted from Sclar & Freeman (1982). (B) Orientation tuning curves of a second neuron, measured using a stimulus that varied in contrast from 10% (*empty circles*) to 80% (*filled circles*). Adapted from Sclar & Freeman (1982). (C) Responses of neuron recorded in area V1 of the anesthetized macaque. Two spatially superimposed gratings appeared within the receptive field. One grating was of the optimal orientation for the neuron, whereas the second grating was of a suboptimal orientation. Each subpanel illustrates responses obtained with a particular combination of contrast for the two stimuli. The preferred grating varied from 0% contrast (*top row*) to 50% contrast (*bottom row*), and the contrast of the poor grating increased from 0% (*left column*) to 50% (*right column*). Adapted from Carandini et al. (1997). Panels D–I show the capacity of several models to account for these contrast-dependent response modulations. See text for details.

when a single grating was presented in the receptive field at different levels of luminance contrast, yielding the neuron’s contrast-response function. Each line is the contrast-response function derived using a grating presented at one of three orientations: the cell’s optimal orientation (top line), a suboptimal but excitatory orientation (middle line), and the cell’s null orientation (bottom line), which was

slightly suppressive. The neuron did not respond to either excitatory stimulus presented below a threshold level of luminance contrast. As is typical of cortical neurons, above this threshold, the response increased over a range of contrasts that comprise the dynamic range of the contrast-response function, before reaching a saturation response. The response to the optimally oriented grating (upper line, black circles) saturated at ~ 130 spikes per second, well above the rate at which a suboptimally oriented grating saturated (black squares, 84 spikes per second).

The second phenomenon is that increasing the contrast of an oriented stimulus characteristically results in a multiplicative increase in the orientation tuning curve, as illustrated in Figure 3B. Each curve in this figure (also adapted from Sclar & Freeman 1982) shows a simple cell's response to gratings presented across a range of orientations. The most shallow orientation tuning curve (open circles) was derived using gratings of 10% luminance contrast, and each successively higher curve corresponds to a doubling of contrast. Note that this multiplicative effect of contrast on the orientation tuning curve follows from the observation that the contrast-response functions derived for any two orientations can be related to each other by a gain factor, as is approximately the case for the two contrast-response functions appearing in Figure 3A.

The above observations involve increases in response when a stimulus increases in contrast. The effect of increasing contrast is qualitatively different when two stimuli appear within the receptive field, where increasing the contrast of one of them can result in increases or decreases in response, depending on the neuron's selectivity for the two stimuli. This finding is illustrated in Figure 3C, which shows data recorded by Carandini et al. (1997) from a neuron in area V1 of the anesthetized macaque, when two spatially superimposed gratings, differing in orientation, appeared simultaneously within the receptive field (see also Bonds 1989, DeAngelis et al. 1992, Morrone et al. 1982). Each subpanel shows the response evoked by a particular combination of contrasts. One grating was of the neuron's preferred orientation, and a second grating was of a suboptimal orientation that nonetheless elicited an excitatory response when presented alone. The contrast of the preferred grating varied from 0% contrast (top row) to 50% contrast (bottom row), and the contrast of the poor grating increased from 0% (left column) to 50% (right column). Because 0% contrast corresponds to the absence of a stimulus, the upper left subpanel shows the neuron's spontaneous activity. Responses elicited by the preferred and poor stimulus presented alone appear in the left column and top row, respectively. The poor stimulus elicited a small but measurable excitatory response that increased with contrast (top row), and yet when paired with the preferred stimulus, it had a suppressive effect. Note, for example, that the response elicited by the 13% contrast preferred stimulus alone (left column, third row) was strongly reduced by the addition of the poor stimulus at 50% contrast (right panel, third row). Figures 3D–I show model fits to the data in Figures 3A–C and will be described below.

The above data were collected when preferred and poor stimuli were spatially superimposed. Similar competitive interactions among superimposed stimuli have

been found in extrastriate visual cortex (Qian & Andersen 1994, Snowden et al. 1991). In the attention studies outlined below, the stimuli appeared at separate locations in the receptive field. It is therefore important to note that contrast-dependent suppressive effects are also observed with nonsuperimposed stimuli. This finding is illustrated in Figure 4, which shows data recorded by Reynolds & Desimone (2003) from a macaque V4 neuron. The first column shows trial-by-trial spike records that illustrate the response of the neuron when a stimulus of the neuron's null orientation appeared alone in the receptive field at luminance contrasts ranging from 5% (bottom panel) to 80% (top panel). The right column shows the response elicited by a stimulus of the neuron's preferred orientation, which was presented at a fixed contrast (40%) at a separate location in the receptive field. The panels are repeated for comparison. The center column shows the response that was elicited by the pair, as a function of poor stimulus contrast. The 5% contrast poor stimulus (bottom panel, center) had no measurable effect on the neuronal response, but at higher levels of contrast it became increasingly suppressive and at 80% contrast (top panel, center) it almost entirely suppressed the response. These observations confirm earlier reports showing that a poor stimulus suppresses the response elicited by a nonsuperimposed preferred stimulus (Miller et al. 1993, Recanzone et al. 1997, Rolls & Tovee 1995; however, see Gawne & Martin 2002). See also Britten & Hauer (1999) and Hauer & Britten (2002) for additional evidence of response normalization in area MT with nonsuperimposed stimuli.

Another form of contrast-dependent response modulation is observed when the second stimulus appears in the surround of the receptive field (Blakemore & Tobin 1972, DeAngelis et al. 1994, Knierim & van Essen 1992, Levitt et al. 1996, Maffei & Fiorentini 1976; see Fitzpatrick 2000 for a review). Suppressive surround effects are commonly attributed to intracortical lateral inhibition. Unlike the contrast-dependent interactions observed when two stimuli appear within the classical receptive field, the maximal suppressive effect of a surround stimulus is usually observed when the stimulus in the surround and the stimulus in the center are both of the neuron's preferred orientation (Cavanaugh et al. 2002a,b;

Figure 4 Increasing the contrast of a poor stimulus at one location suppresses the response elicited by a fixed contrast preferred stimulus at a second location in the receptive field of a V4 neuron. The contrast of the poor stimulus, illustrated in the first column, ranged from 5% to 80%. As indicated in the first column of raster plots, this stimulus did not elicit a clear response at any contrast. The right column shows the response elicited by the preferred stimulus, which was fixed in contrast (panels repeated down the column, for comparison). The middle column of raster plots shows the response to the pair. At low contrast (*bottom panel*), the poor stimulus had no measurable effect on the response to the preferred stimulus, but as poor stimulus contrast increased (moving up the column), it became increasingly suppressive, almost entirely suppressing the response at high contrast (*top panel*). Adapted from Reynolds & Desimone (2003).

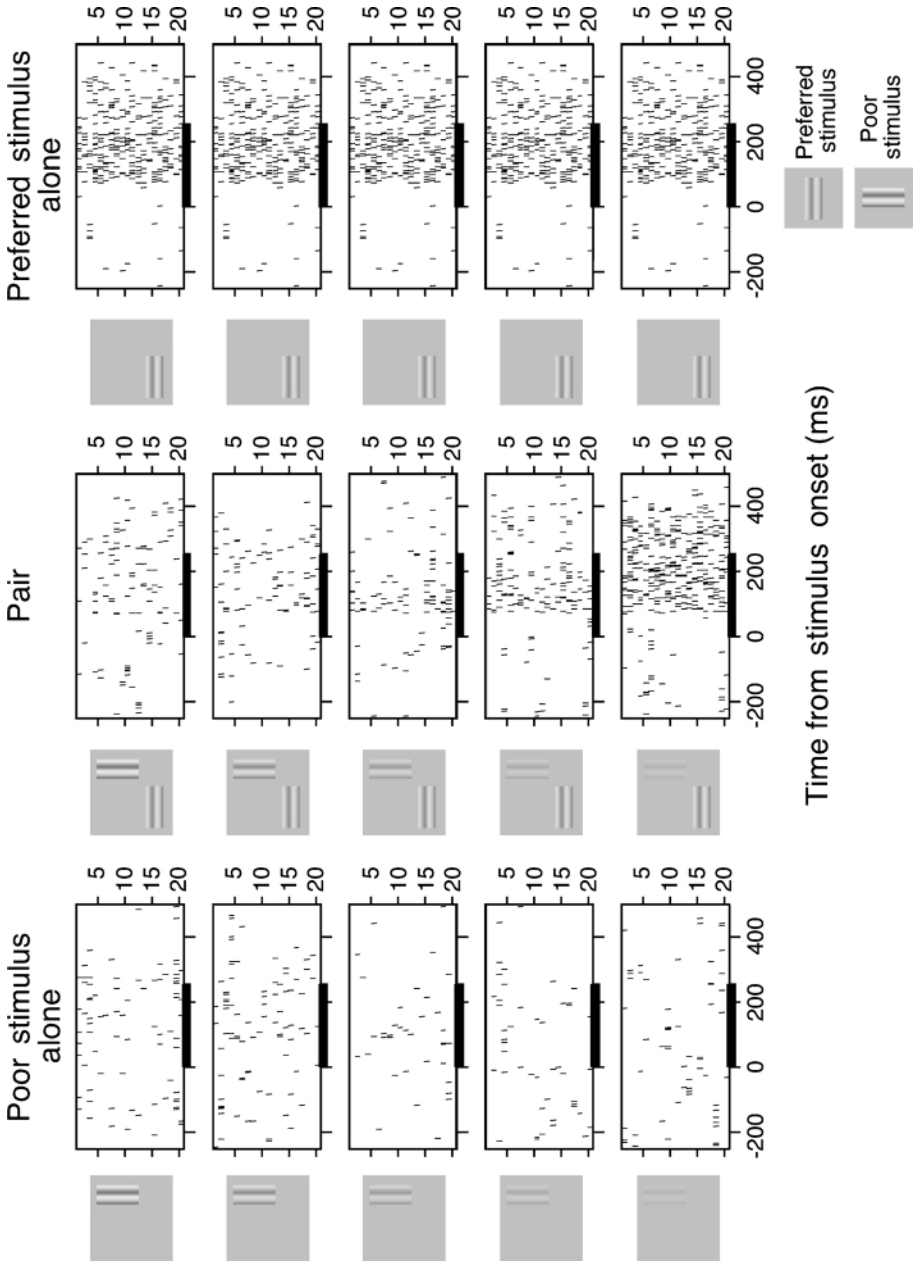

DeAngelis et al. 1994). Evidence exists that such surround effects rely on divisive inhibition from the receptive field surround tuned for the neuron's preferred orientation (Cavanaugh et al. 2002a,b; Muller et al. 2003; Webb et al. 2003). The effect of varying the contrast of a stimulus in the surround is illustrated in the top two panels of Figure 5, which show responses of two neurons recorded by

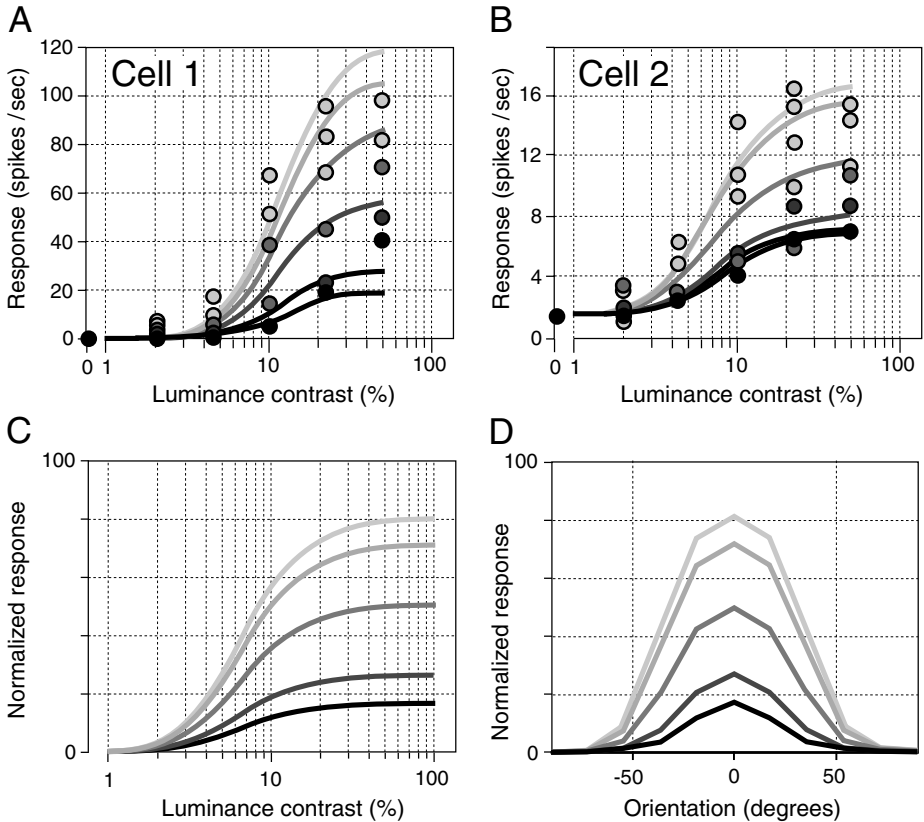

Figure 5 Effect of increasing the contrast of a stimulus in the receptive field surround. Panels *A* and *B* show the responses of two neurons recorded from area V1 of the anesthetized macaque. In this experiment, a circular grating of the neuron's preferred orientation appeared in the receptive field center, in the presence of a second grating in the surround. The circles in each panel indicate responses to the pair of gratings, with the shading of each circle indicating the contrast of the surround grating. Darker shading corresponds to higher contrast. The horizontal axis indicates the contrast of the stimulus in the center of the receptive field. The lines represent model fits to the experimental data. Adapted from Cavanaugh et al. (2002a). (*C*) If the model by Reynolds et al. (1999) is augmented to include an inhibitory surround, it also exhibits this contrast-dependent suppression, which results in a divisive reduction in the orientation tuning curve for the center stimulus (*panel D*).

Cavanaugh et al. (2002a) in area V1 of the anesthetized macaque. In their experiment, a circular grating of the neuron's preferred orientation appeared in the receptive field center, in the presence of a second grating in the surround. The circles in each panel indicate responses to the pair of gratings, with the shading of each circle indicating the contrast of the surround grating. Darker shading corresponds to higher contrast. The horizontal axis indicates the contrast of the stimulus in the center of the receptive field. The lines represent model fits and are discussed below. The effect of increasing the contrast of the surround stimulus is to suppress the response elicited by the preferred stimulus in the center, and Cavanaugh et al. found that this suppression is best described as a multiplicative reduction in the response throughout the contrast-response function.

THESE CONTRAST-DEPENDENT RESPONSE PROPERTIES CAN BE EXPLAINED BY EXISTING MODELS OF THE LOCAL CIRCUIT THAT RELY ON SUPPRESSION

The response properties described above are among the most thoroughly studied in visual neurophysiology, and they have driven the development of increasingly detailed models of the underlying cortical circuit (Albrecht & Geisler 1991, Carandini & Heeger 1994, Carandini et al. 1997, Grossberg 1973, Heeger 1992, McLaughlin et al. 2000, Murphy & Miller 2003, Somers et al. 1995, Sperling & Soodhi 1968, Troyer et al. 1998; for recent reviews, see Ferster & Miller 2000, Geisler & Albrecht 2000, Shapley et al. 2003). These models differ in important respects, such as the relative importance of feedforward inhibition, the role of shunting inhibition, the degree to which inhibition is tuned, and the importance of mutually excitatory interactions between similarly tuned neurons. Which model provides the best approximation to the true microcircuit (which itself may differ in some respects across cell types, according to laminar distribution, across brain areas, and across species) is not yet known. Although these differences are very important, it is beyond the scope of this review to describe them in detail. We therefore simply illustrate fits derived from three of the above models to document their capacity to account for the contrast-dependent response modulations illustrated in Figures 3 and 5.

However, to fix ideas, we begin by outlining briefly the key assumptions of one model, the normalization model, which is described in a recent paper by Carandini et al. (1997). The model is closely related to models proposed by Heeger (1992) and Carandini & Heeger (1994). It has some features in common with models proposed by Albrecht & Geisler (1991), Grossberg (1973), and Sperling & Soodhi (1968). It provides a simple account for the contrast-dependent modulations illustrated in Figures 3A–C and, when suitably extended to include a receptive field surround (Cavanaugh et al. 2002a,b), can also account for the contrast-dependent surround effects appearing in Figure 5. The model achieves orientation selectivity as a result of tuned excitatory input, which is stronger for a preferred orientation stimulus

than for a nonpreferred stimulus. This excitatory drive increases with contrast, as does a feature nonselective shunting inhibitory drive. Shunting inhibition refers to a synaptically activated conductance with a reversal potential near the resting potential of a neuron. Activating shunting inhibition decreases the input resistance of the cell, which diminishes potential changes induced by excitatory inputs. This action has a divisive effect on subthreshold excitatory postsynaptic potential amplitudes, and the model assumes that this reduction has a divisive effect on firing rate (however, see Holt & Koch 1997). When two stimuli appear together, the effect of varying the contrast of either stimulus depends on the relative contributions of excitatory and divisive inhibitory drive. When a poor stimulus (with proportionally more inhibitory drive) is presented with a preferred stimulus, the additional inhibitory input results in a suppressed response. This response suppression can be magnified by increasing the contrast of the poor stimulus or can be diminished by increasing the contrast of the preferred stimulus.

The capacity of this and two other models to account for contrast-dependent response modulations is documented in Figures 3 and 5. Figure 3*D* illustrates the contrast-response functions that emerge from a model proposed by Somers et al. (1998), which is an extension of an earlier model introduced by Somers et al. (1995). Like the normalization model, this model relies on inhibition to account for orientation-specific saturation responses. However, it differs from the normalization model in several respects, including the fact that it does not depend on shunting inhibition and that it relies on recurrent cortical excitation to sharpen its weakly orientation-tuned excitatory input. Dashed lines in Figure 3*D* show model responses to gratings of the optimal orientation (upper dashed) and a suboptimal but excitatory orientation (lower dashed), when intracortical connections were silenced and only thalamocortical inputs were active. The solid lines show model responses to the same two stimuli when intracortical connections were included. The effect of the intracortical connections was to cause the model neuronal response to saturate, while maintaining selectivity for the two stimuli across contrast.

Figure 3*E* illustrates the contrast-invariant tuning that emerges from a model introduced by Troyer et al. (1998). This model incorporates a number of nonlinearities to explain the contrast-dependent gain changes in orientation tuning, including small contrast-dependent conductance changes, spike-rate adaptation currents, and synaptic depression. Each curve indicates the model response across orientation, at different levels of contrast, ranging from 2.5% (lowest curve) to 50% contrast (highest curve). At 5% contrast and above, the orientation tuning curves are approximately related to each other by a multiplicative factor.

Figure 3*F* demonstrates the ability of the model by Carandini et al. (1997, described above) to account for the contrast-dependent suppressive effect of adding a poor stimulus to a preferred stimulus. The circles indicate the mean firing rates taken from the data in Figure 3*C*, with shading indicating the luminance contrast of the preferred orientation grating, ranging from 0% (white) to 50% (black). The contrast of the poor orientation grating is indicated on the horizontal axis. The lines indicate the model's best fit to the data.

Note that the response elicited by the poor stimulus increases with contrast, indicating that although it was poor, it was nonetheless excitatory. The model accounts for the fact that, despite this excitatory effect when presented alone, increasing the contrast of the poor stimulus suppressed the response elicited by the simultaneously presented preferred stimulus. Note, for example, that the response elicited by the 13% contrast preferred stimulus alone (~ 22 spikes per second, dark gray data point, left) was strongly reduced by the addition of the poor stimulus at 50% contrast (~ 8 spikes per second, dark gray data point, right). The model also accounts for the fact that increasing the contrast of the preferred grating had the opposite effect: It increased the response to the pair. The highest contrast preferred stimulus (black circles) was virtually immune to this suppressive effect.

Cavanaugh et al. (2002a,b) have extended the model of Heeger & Carandini (1994) to include a divisive inhibitory surround, and with this addition, the model can account for changes in the response to a stimulus in the receptive field center when a second stimulus, in the surround, is varied in contrast. The model's ability to account for this contrast-dependent, center-surround modulation is documented in the upper two panels of Figure 5. The lines indicate model fits to these data, with darker lines corresponding to higher surround contrast. The model fits capture the effect of increasing the contrast of the surround stimulus, which was to suppress the response elicited by the preferred stimulus in the center.

A LINKING HYPOTHESIS: DIRECTING SPATIAL ATTENTION TO A STIMULUS INCREASES ITS EFFECTIVE CONTRAST

How could these local circuit models account for (a) the response facilitation that is often observed when attention is directed to a single stimulus appearing alone within the receptive field, and (b) the observation that when two stimuli appear within a neuron's receptive field, the neuronal response is dominated by the stimulus that is relevant to current behavior? First, consider the effect of elevating the contrast of a single stimulus, as illustrated in Figures 3A and 3B. Elevating the contrast of a just-subthreshold stimulus will push it above threshold, thereby eliciting a response. For stimuli falling within the dynamic range of the contrast-response function, elevating contrast leads to a more robust response. Thus, if attention operates by increasing the effective contrast of a stimulus, this elevation of effective contrast would account for the elevations in response found when attention is directed to a single stimulus—the idea of attentional facilitation, described above.

Second, consider how changes in contrast modulate the response when two stimuli—a preferred stimulus and a poor stimulus—appear together within the receptive field. As illustrated in Figures 3C, 3F, and 4, the poor stimulus suppresses the response elicited by the preferred stimulus, and the magnitude of this suppression depends on the relative contrasts of the two stimuli. At low contrast, the poor stimulus has little or no suppressive effect, but as the contrast of the poor stimulus increases, it drives the response downward. This suppression is

diminished if the preferred stimulus is presented at high contrast. Thus, increasing the contrast of one of the two stimuli causes a change in the neuronal response similar to that observed when attention is directed to it: It causes the stimulus to dominate the neuronal response, just as attention causes the neuron to selectively process information about the stimulus that is relevant to the animal's current behavioral goals. An appealing linking hypothesis is that attention operates by multiplying the effective contrast of the behaviorally relevant stimulus, a result that could be achieved by increasing the neuron's contrast sensitivity for the attended stimulus.

This idea is incorporated into a model of attention developed to provide an account of how the behaviorally relevant stimulus gains preferential control over neuronal responses in the visual cortex. This model, described in detail elsewhere (Reynolds et al. 1999), was conceived as a way of formalizing the biased competition model of Desimone & Duncan (1995). Because it operates by multiplying the effective contrast of the attended stimulus, we refer to it as the contrast gain model of attention. It is a functional model in that it is intended to characterize the operations performed by the neural circuit without committing to specific biophysical or biochemical mechanisms. However, it is mathematically related to models that have been used to explain the contrast-dependent effects described above. Therefore, this model can account for the same set of contrast-dependent phenomena, as documented in Figures 3*G–I* and 5*C*.

Figure 3*G* shows the model contrast-response functions for an optimal (upper dashed line) and a suboptimal but excitatory stimulus (lower dashed line). Orientation selectivity arises from differences in the strength of excitatory input across orientation, so here, the optimally oriented stimulus activated greater excitatory input than did the suboptimal stimulus. Inhibitory input was untuned for orientation. Attention leads to increases in the strength of excitatory and inhibitory inputs activated by the attended stimulus (Reynolds et al. 1999), as would occur when increasing the contrast of the stimulus. The effect of this change is to shift the model contrast-response function to the left, as indicated by the arrows. Figure 3*H*, which was obtained using the same set of parameters that yielded Figure 3*G*, documents the ability of the model to exhibit multiplicative increases in the orientation tuning curve with increasing contrast. The vertical lines indicate the orientations whose contrast-response functions are illustrated in Figure 3*G*. Because attention yields a shift in effective contrast, its influence on the tuning curve is the same as an increase in contrast: to cause a multiplicative increase in the tuning curve. This finding is illustrated by the upward arrows, which show the increases in response that result from a leftward shift in the contrast-response function for the two orientations whose contrast-response functions are illustrated in Figure 3*G*.

Figure 3*I* shows the model behavior when the preferred stimulus from Figure 3*G* appears together with a nonpreferred but excitatory stimulus also in the receptive field, at various levels of contrast. As is the case experimentally (Figures 3*C*, 3*F*, 4), the model accounts for the finding that elevating the contrast of the poor stimulus will increase its ability to suppress the response to a fixed-contrast

preferred stimulus. Thus, the model accounts for the finding that when two stimuli appear in the receptive field, attending to the more preferred stimulus will cause an elevation in response, and attending to the poor stimulus will lead to a reduction in response.

The model, as originally described by Reynolds et al. (1999), does not specify the geometry of the receptive field, but if we take the lead of Cavanaugh et al. (2002a,b) and assume that the inhibitory kernel extends beyond the excitatory center of the receptive field, the model can then provide a qualitative account for the contrast dependence of the inhibitory surround. This idea is illustrated in Figure 5C, which shows the response of the model using the same parameters that were used to derive Figures 3G–I but with the addition of a purely inhibitory input increasing monotonically with surround-stimulus contrast. Figure 5D shows the model output as a function of the orientation of the center stimulus. As the contrast of the surround stimulus increases, this divisively reduces the response evoked by the center stimulus at each level of contrast. As we summarize below, this has relevance to single-unit recording studies in which monkeys attended to a stimulus in the surround.

ATTENTION-DEPENDENT RESPONSE MODULATIONS MIRROR THE EFFECTS OF A MULTIPLICATIVE INCREASE IN STIMULUS CONTRAST

A number of recent single-unit recording and lesion studies of attention in the macaque have likened attention to increasing visual salience (Bisley & Goldberg 2003; De Weerd et al. 1999; Gottlieb et al. 1998; Martínez-Trujillo & Treue 2002; McAdams & Maunsell 1999a; Reynolds et al. 1999, 2000; Reynolds & Desimone 2003; Treue 2003). Reynolds et al. (2000) directly tested the idea that spatial attention causes a multiplicative increase in the effective contrast of a stimulus. If it does, then as illustrated in Figure 3G, attention should cause a leftward shift in the contrast-response function. Such a leftward shift would predict (a) that the threshold level of contrast required to elicit a neuronal response should decrease, (b) that the largest increases in firing rate should be observed for stimuli that are within (or just below) the upward sloping part of the contrast-response function (the dynamic range of the cell's contrast-response function), and (c) that attention should have little or no effect on the firing rate elicited by a stimulus above the dynamic range.

To test these predictions, luminance-modulated gratings were presented within the receptive fields of V4 neurons as monkeys performed a task that required them either to attend to the location of the gratings, or else, on separate trials, to attend to another location far from the receptive field. The monkey's task was to detect a target grating that could appear at an unpredictable time at the cued location. The luminance contrast of each target was selected at random, so to perform the task reliably, the monkey had to continually attend to the location of the upcoming

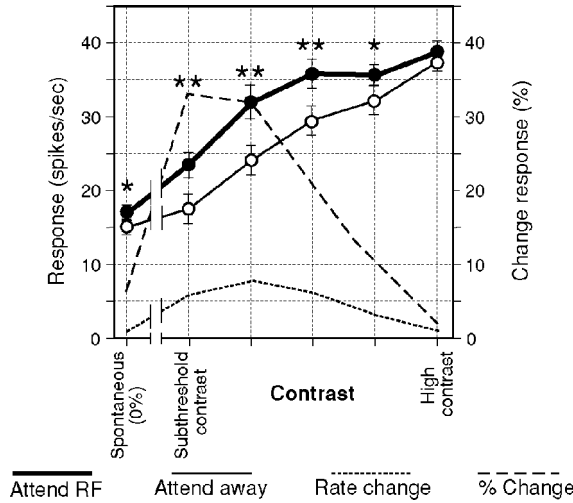

Figure 6 Attention-dependent increases in contrast sensitivity. Each line shows the average responses of a population of area V4 neurons. The monkey attended either to the location of the receptive field stimulus (*thick line, black circles*) or to a location far away from the receptive field (*thin line, white circles*). Luminance-modulated gratings were presented inside the receptive field at five different values of contrast selected to span the dynamic range of each neuron. The monkey's task was to detect a target grating that could appear at an unpredictable time at the cued location. The dashed and dotted lines show, respectively, percent and absolute difference in firing rate across the two attention conditions, as a function of contrast. Adapted from Reynolds et al. (2000).

target. Each grating was presented at a contrast drawn at random from a set of five contrasts that were selected to span the dynamic range of the neuron. Consistent with the predictions of the contrast-gain model, attention caused a reduction in neurons' contrast-response thresholds, caused the strongest increases in response for stimuli within or below the dynamic range of the neuron's contrast-response function, and caused only minimal changes in response for stimuli that were at saturating contrast. This was the case for the neuron illustrated in Figure 1, which showed no change in firing rate with attention at saturating contrast (80%), but which exhibited a clear reduction in response threshold with attention. Figure 6 shows the contrast-response function, averaged across the population. The thin solid line shows the response when attention was directed away from the receptive field, and the thick solid line shows the response to the identical stimuli, when they were attended. The dashed and dotted lines show percent and absolute difference in firing rate across the two attention conditions, as a function of contrast. At zero contrast (no stimulus present), there was a slight elevation in spontaneous activity, consistent with previous reports (e.g., Luck et al. 1997). For stimuli chosen to be below each neuron's contrast-response threshold (subthreshold contrast), there

was a clear and significant response. The largest increases in firing rate were observed over the contrasts that were chosen to span the dynamic range of each neuron's contrast-response function. There was no significant effect of attention at the highest contrast tested, which was chosen to be at or slightly above saturating contrast. Similar results were found for both preferred and poor stimuli. In both cases, attention shifted the contrast-response function to the left, consistent with the prediction illustrated in Figure 3G. A detailed analysis of the data derived from this experiment found that for a cell to detect an unattended stimulus as reliably as it could detect an attended stimulus, the unattended stimulus would have to be half again as high in contrast as the attended stimulus. That is, under the conditions of this experiment, attention was worth a 51% increase in contrast, in terms of improving stimulus detectability. Although this value would be expected to change as a function of task difficulty (Spitzer et al. 1988) and brain area (Cook & Maunsell 2002, Luck et al. 1997) it is corroborated by other studies that have also quantified spatial attention in units of luminance contrast, including studies conducted in MT by Martínez-Trujillo & Treue (2002) and in V4 by Reynolds & Desimone (2003), who estimated that attending to a stimulus was equivalent to increasing its luminance contrast by 50% and 56%, respectively.

Motter (1993) observed a pattern of responses consistent with the proposal that attention increases the effective contrast of a stimulus. He recorded neuronal responses in V1, V2, and V4, using bars of intermediate levels of contrast. For some neurons, responses were stronger when attention was directed to the stimulus in the receptive field, in contrast to when attention was directed to another stimulus outside the receptive field. Notably, this difference in response was greatest for stimuli presented near the peak of the neuron's orientation tuning curve, as would be expected if attention caused a multiplicative increase in the tuning curve. McAdams & Maunsell (1999a) carefully quantified attention-dependent changes in the orientation tuning curve and found that spatial attention does cause a multiplicative increase in the orientation tuning curve, without otherwise altering its shape. In their experiment, they held contrast constant and varied the orientation of a grating appearing alone in the receptive field. On some trials, monkeys attended to the stimulus in the receptive field to report whether two successive gratings differed in orientation. On other trials, they attended to stimuli appearing at a location across the vertical meridian to report whether they differed in color. This enabled McAdams & Maunsell to map out the neuron's orientation tuning curve under identical sensory conditions and to measure how it changed with attention. As illustrated in Figure 7, attending to the receptive field caused a multiplicative increase in the neuron's orientation tuning curve. A related study demonstrated that this increase in the gain of the orientation tuning curve enabled neuronal signals to better distinguish the orientation of the stimulus (McAdams & Maunsell 1999b).

A third model property is that when two stimuli appear in the receptive field, attending to one of them will cause either an increase or a decrease in response, depending on the cell's relative preference for the two stimuli (see Figure 3I), with the magnitude of these changes growing in proportion to the neuron's selectivity

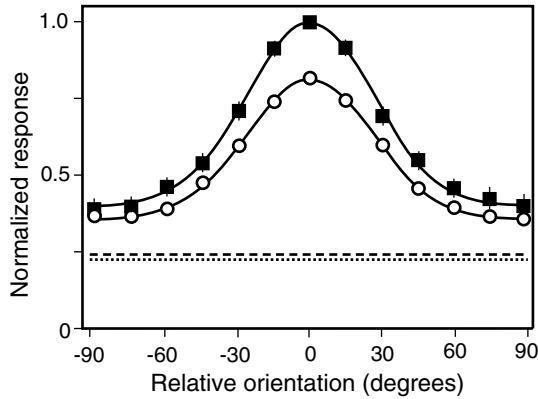

Figure 7 Attention increases tuning curves by a gain factor. Average normalized orientation tuning curves computed across a population of area V4 neurons while the monkey attended either to the location of a grating stimulus inside the receptive field (*filled squares*) or to a location in the opposite hemifield (*empty circles*). The upper curve is approximately a multiplicative version of the lower curve. Adapted from McAdams & Maunsell (1999a).

for the two stimuli. As mentioned earlier, this pattern has been observed in several single-unit recording studies of attention (Chelazzi et al. 1998, 2001; Luck et al. 1997; Martínez-Trujillo & Treue 2002; Reynolds et al. 1999; Reynolds & Desimone 2003; Treue & Martínez-Trujillo 1999; Treue & Maunsell 1996). Figure 8, adapted from a study conducted by Treue & Martínez-Trujillo, illustrates attention-dependent increases and decreases in firing rate. Two patterns of dots appeared within the classical receptive field of an MT neuron. One of them (“pattern A” in Figure 8A) moved in the null direction for the neuron, and the other (“pattern B”) moved in one of twelve directions of motion, selected at random on each trial. The monkey either attended to the fixation point to detect a change in its luminance or, on separate trials, attended to one of the two patterns of dots to detect a change in the direction or speed of its motion. The neuronal response when attention was directed outside the receptive field is indicated by the middle curve in Figure 8B, which shows responses averaged over 56 neurons (sensory response), aligned on the each neuron’s preferred direction of motion. Because pattern A moved in each neuron’s null direction, pattern B was the more preferred stimulus over a range of contrasts. Over this range, attending to pattern B elevated the response, with the magnitude of this increase growing in proportion to the neuron’s selectivity for the two stimuli. When attention was directed to the null stimulus, the response was reduced, again, with changes growing in proportion to selectivity.

A final prediction that follows from the idea that attention is equivalent to an increase in contrast is illustrated in Figure 5D. As noted above, increasing

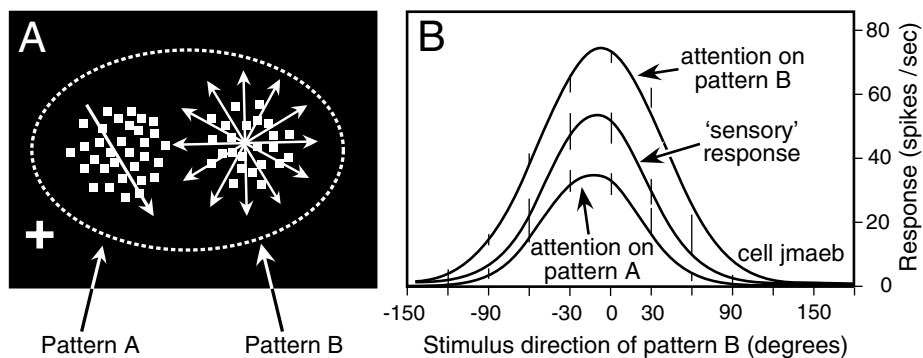

Figure 8 Attention to a poor stimulus decreases the response to a pair of stimuli in MT, and attention to a preferred stimulus elevates the response. (A) Stimuli. Two patterns of dots appeared simultaneously in the receptive field of an MT neuron. One pattern (pattern A) moved in the cell's null direction. The other pattern (pattern B) moved in a direction that varied from trial to trial. (B) Responses averaged across a population of MT neurons. The center line shows the tuning curve to the pair, as a function of the orientation of Pattern B, when the monkey attended to the fixation point to detect a change in luminance (the sensory response). When attention was directed to the null stimulus (pattern A) the response was reduced (*bottom line*). When attention was directed to pattern B, the response was increased. These increases and decreases reflect a combination of both spatial and feature-based attention, which were found to combine additively. Adapted from Treue & Martínez-Trujillo (1999).

the contrast of a stimulus in the surround causes suppressive effects that are well characterized as a multiplicative reduction in the neuronal response, and this effect has been modeled using a variant of the divisive normalization model described above. If attention is equivalent to an increase in contrast, then, as illustrated in Figure 5D, the effect of directing attention toward a stimulus in the receptive field surround should be to reduce the gain of the orientation tuning curve derived from a stimulus in the receptive field center.

This prediction has not been tested directly, but several studies provide provisional support for the proposal that attention modulates center-surround interactions. Ito & Gilbert (1999) measured the effect of directing attention to bars appearing within the receptive fields of neurons in the primary visual cortex of the macaque. They found that whereas attention had no effect when the bar appeared alone in the receptive field, it had a pronounced effect when colinear bars appeared in the receptive field surround, which suggests that attention modulated the sensory interactions between center and collinear surround stimuli. Connor et al. (1996, 1997) found that V4 responses evoked by a stimulus in the RF changed when attention was directed to one of several stimuli in the surround. Responses were often stronger when attention was directed to a stimulus near the location of the probe, possibly reflecting either the falloff of facilitation with distance from the attended location, an increased likelihood of a shift of attention to probes appearing

near the attended stimulus, or a shift in the receptive field. They also found a much larger change in the overall responsiveness of the neuron, depending on which surround stimulus was attended. Connor and colleagues did not measure center-surround interactions, but it seems plausible that these changes in response may have resulted from modulation of spatially asymmetric center-surround modulations, as have been found in cat primary visual cortex (Xiao et al. 1995) and in macaque area MT (Walker et al. 1999). Connor and colleagues concluded that such position-dependent changes in responsiveness could help encode the position of stimuli with respect to the locus of attention, which could be useful for object recognition (Salinas & Abbott 1997).

Motter (1993) provided what is perhaps the most direct evidence that attention modulates center-surround interactions. He examined attention-dependent changes in the orientation tuning curve. As noted above, Motter found that some neurons showed an increase in response when attention was directed to a single stimulus within the receptive field. He also found, however, that many neurons were modulated by attention only when multiple stimuli appeared in the visual field. He did not explicitly measure the suppressive surrounds of the neurons he studied. However, the pattern of suppressive effects he observed when attention was directed to stimuli outside the receptive field is consistent with the pattern that would be predicted if attention increased the effective contrast of stimuli in the surround. He examined whether the attention effect reflected an increase in response when attention was directed to the center stimulus or a decrease in response when attention was directed to one of the stimuli outside the receptive field. He measured orientation tuning curves when the center stimulus appeared alone in the visual field during passive fixation and compared these curves with tuning curves measured when the monkey attended either to the stimulus in the receptive field or to one of the extrareceptive field stimuli. For about 50% of the cells modulated by attention under these conditions, attention to the stimulus in the surround caused a reduction in response, especially at the peak of the orientation tuning curve. This attention effect is illustrated in Figure 9, which shows the response for one such neuron. The upper dashed line shows the orientation tuning curve mapped out during fixation. The lower dashed line shows the tuning curve that was mapped out when the monkey attended to the stimulus in the receptive field. There is no clear difference. However, when the monkey attended to the stimuli that appeared outside the classical receptive field, including those in the surround, the peak responses were reduced in magnitude.

SOURCES OF SIGNALS THAT MODULATE RESPONSES IN VISUAL CORTEX

The experiments described above demonstrate that spatial attention causes changes in the neuronal response that mirror the effects of increasing the effective contrast of the attended stimulus. Research from many laboratories using a variety of different

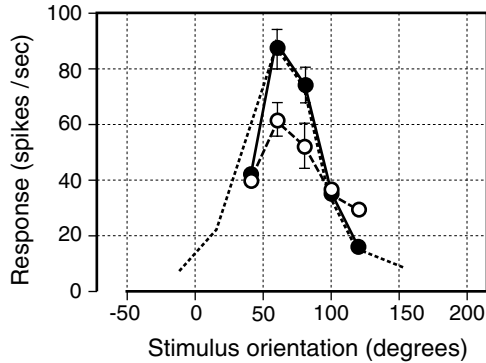

Figure 9 The orientation tuning curve of a V2 neuron was suppressed when the monkey attended to stimuli appearing outside the receptive field. The upper dashed line shows the tuning curve measured when the stimulus in the receptive field appeared alone, during passive fixation. The solid lines show the tuning curve measured when additional stimuli were present outside the receptive field, and the monkey attended to the stimulus in the receptive field (*black circles*). The lower dashed line (*white circles*) shows the tuning curve measured when the monkey attended to the stimuli outside the field. Attending to the stimuli outside the receptive field reduced the response when the stimulus in the receptive field was presented at the neuron's preferred orientation.

techniques have identified potential sources for the feedback signals that modulate visual cortical responses during spatially directed attention (for a recent review, see Corbetta & Shulman (2002)). These sources include the pulvinar (reviewed by Sherman (2001)), parts of the parietal cortex (Bisley & Goldberg 2003, Colby & Goldberg 1999, Gottlieb et al. 1998, Mountcastle et al. 1987, Steinmetz & Constantinidis 1995), the frontal eye field (FEF; reviewed by Schall 1995), and the superior colliculus (Basso & Wurtz 1998, Wurtz & Goldberg 1972). Space constraints preclude us from detailing the important advances made over the past decade in understanding the roles of these structures in guiding spatial attention. We therefore mention briefly two experiments that have directly examined the role of one of these structures (FEF) in modulating contrast sensitivity at the behavioral and neuronal levels.

Investigators have long known that FEF plays a role in the control of saccadic eye movements (Robinson & Fuchs 1969) and in the selection of stimuli during visual search (for a review, see Thompson et al. 2001). Sensitivity to stimuli is increased at the location targeted by an impending saccade (Chelazzi et al. 1995, Hoffman & Subramaniam 1995, Moore et al. 1998, Shepherd et al. 1986). FEF has direct anatomical projections to visual areas that are modulated by spatial attention, including areas V2, V3, V4, MT, MST, TE, and TEO, as well as to other potential sources of top-down attentional control, such as area LIP (Stanton et al. 1995).

To establish a causal link between attention-dependent increases in contrast sensitivity and FEF activity, Moore & Fallah (2004) measured changes in contrast

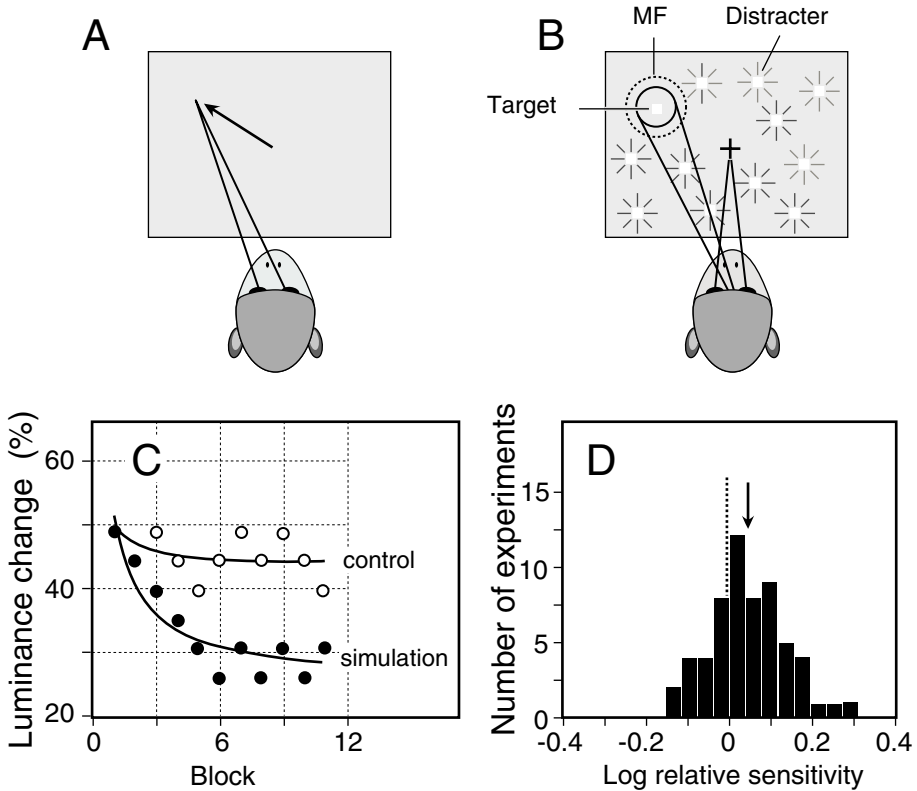

Figure 10 Microstimulation of FEF increases contrast sensitivity. (A) Microstimulating a site in FEF at high current moves the eyes from fixation to a location referred to as the movement field. (B) During the attention task, the monkey maintained fixation while attending to a target within the movement field (MF) to detect a slight change in luminance. Distracters appeared throughout the visual field. On randomly selected trials, current was injected into FEF at levels too low to elicit an eye movement. (C) A staircase procedure was used to determine threshold luminance changes with (black circles) and without (white circles) FEF stimulation. Thresholds were reduced by FEF stimulation. (D) For each session, the change in sensitivity was computed by taking the ratio of threshold luminance changes with and without FEF stimulation. Across sessions, contrast sensitivity increased, as indicated by the rightward shift in the histogram. Adapted from Moore & Fallah (2001).

detection thresholds following electrical stimulation of FEF neurons. As illustrated in Figure 10A, electrical stimulation of FEF neurons causes the eyes to move from the fixation point to a particular location, referred to as the movement field of the neurons at the stimulation site. After determining the movement field, Moore & Fallah had monkeys perform a task, in which they reported a brief change in

the luminance of a target stimulus, to earn a juice reward. The target appeared either inside or outside the movement field. Distracter stimuli appeared randomly at locations throughout the visual field, which increased task difficulty (Figure 10B). On a randomly selected subset of trials, Moore & Fallah injected current calibrated to be too weak to elicit an eye movement. They used a staircase procedure to determine the minimum luminance change required for the monkey to achieve a threshold level of performance, on trials with and without stimulation. Stimulation reduced the level of luminance contrast required to reliably detect the change. This finding is illustrated for an example session in Figure 10C, which shows the contrasts generated by the staircase procedure used to determine threshold. For this session, stimulation reduced the threshold luminance change from 44% to 28%. The effect of microstimulation was spatially specific: The monkey only benefited from stimulation when the target appeared within the movement field. Across sessions, stimulation improved sensitivity, as indicated by the rightward shift in the distribution of changes in sensitivity appearing in Figure 10D. These results thus show that stimulation of FEF improves contrast sensitivity at the movement field location, in much the same way that spatial attention improves contrast sensitivity in V4 neurons (Reynolds et al. 2000).

Moore & Armstrong (2003) reasoned that FEF stimulation might, therefore, cause increased responsiveness in V4 neurons. To test this hypothesis, they identified the site in FEF whose movement field overlapped with the receptive fields of a set of neurons in area V4 and measured the effect of FEF microstimulation on neuronal responses in V4 (see Figure 11A). They found that FEF stimulation caused the neuronal response to increase. This increase in response with FEF stimulation is illustrated in Figure 11B, which shows responses of a single V4 neuron with and without stimulation. The time course of stimulus presentation (RF stim) and current injection (FEF stim) are illustrated at the top of the panel. The neuronal responses in the two conditions are indicated at the bottom of the figure. Stimulation was injected 500 ms after the appearance of the stimulus, at which point the stimulus-evoked response had begun to diminish in strength. The average response on microstimulation trials (*gray*) was clearly elevated following electrical stimulation, relative to nonstimulation trials. This increase in response did not simply reflect antidromic activation directly from FEF, as there was no increase in baseline activity when FEF stimulation occurred in the absence of a visual stimulus in the receptive field. Moore & Armstrong (2003) did not vary luminance contrast. However, consistent with an increase in effective contrast, they found that stimulation caused a greater increase in response when a preferred stimulus appeared in the receptive field, in contrast to when a poor stimulus appeared in the RF. This finding is illustrated in Figure 11C. The left two bars show the mean increase in response caused by stimulation when a nonpreferred (np) or a preferred (p) stimulus was present in the receptive field.

In a final set of conditions, Moore & Armstrong found that FEF microstimulation appeared to filter out the suppressive influence of distracter stimuli appearing outside the receptive field. They placed a second visual stimulus outside

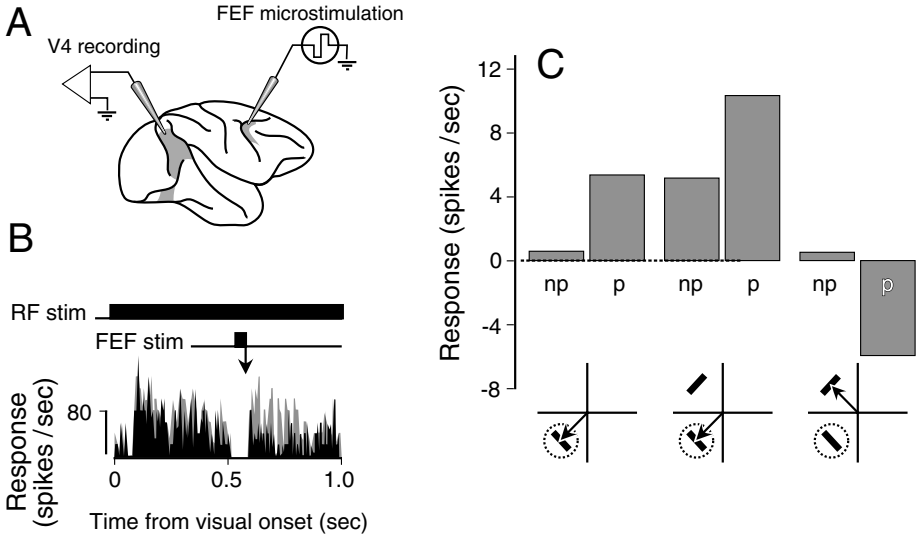

Figure 11 FEF microstimulation increases neuronal responsiveness in V4. (A) Subthreshold microstimulating current was injected into FEF while neuronal activity was recorded from V4. (B) The visual stimulus appeared for one second (RF stim). And 500 ms after the onset of the visual stimulus, FEF was electrically stimulated for 50 ms (FEF stim). The response of a single V4 neuron with (*gray*) and without (*black*) FEF microstimulation appears below. The apparent gap in response reflects the brief period during which V4 recording was paused while current was injected into FEF. Following this interruption, recording continued. The V4 neuron had elevated responses on trials when FEF was electrically stimulated, as compared to trials without FEF stimulation. (C) Mean effect of FEF stimulation with various stimulus configurations. See text for details. Adapted from Moore & Armstrong (2003).

the receptive field and examined the effect of stimulating the portions of FEF whose movement fields corresponded to the RF. They found that the addition of the distracter outside the classical receptive field often led to a reduction of the response elicited by the stimulus in the center, in particular when the center stimulus was a preferred stimulus for the cell, consistent with divisive surround inhibition. Then, when they stimulated FEF, the neuronal response increased. This increase was more than twice the increase observed in the absence of an extra-RF stimulus, consistent with the proposal that stimulation modulated center-surround interactions. In a final condition, they tested whether they could magnify the suppressive effect of the extra receptive field stimulus. They moved their electrode to the FEF location corresponding to the suppressive distracter. Microstimulation resulted in a marked suppression of the response elicited by the preferred stimulus in the RF (rightmost bar). Stimulation at the same location when the distracter was absent had no effect on the response of the recorded V4 neuron. These stimulation findings are strikingly consistent with Motter's (1993) observation that directing

spatial attention to an extra-RF stimulus often leads to a decrease in firing rate elicited by a preferred stimulus in the center.

These studies thus establish that FEF microstimulation has effects at the behavioral and at the neuronal level which mimic the effect of spatial attention. At the behavioral level, FEF stimulation causes an increase in contrast sensitivity. At the neuronal level, it increases the response elicited by a stimulus in the RF, an effect that is stronger for a stimulus that is of the neuron's preferred orientation. Stimulation of an FEF site whose movement field corresponds to a stimulus outside the RF magnifies the suppressive influence of the extra receptive field stimulus.

MECHANISMS OF RESPONSE ENHANCEMENT

The experiments described above indicate that spatial attention involves feedback signals from areas, including the FEF, which modulate the responses of visual cortical neurons in ways that mimic increases in the contrast of the attended stimulus. Recent intracellular recording studies using the dynamic clamp technique provide insight into how such a change in effective contrast could take place, by characterizing how changes in the variance of excitatory and inhibitory inputs to a neuron can change its sensitivity to excitatory input. The dynamic clamp technique makes it possible to simulate different patterns of conductance changes that result from the activity of a network of neurons that synapse on a recorded neuron, and to measure their influence on the neuron's response to injected current. Chance et al. (2002) used this technique to record the responses of rat cortical neurons to a steady injected current at different amplitudes. They could change the neuronal response gain by introducing a noisy barrage of excitation and inhibition. Excitation and inhibition were balanced to avoid directly changing the average membrane potential of the neuron. Fellous et al. (2003) extended this finding by varying excitatory and inhibitory modulatory inputs separately (see also Shu et al. 2003 for related findings). Their experiments show that an increase in the variance of either inhibitory or excitatory synaptic inputs can increase neuronal gain. The most obvious way to increase the variance of inputs, and thus to improve neuronal sensitivity, would be to increase the degree of correlation between the neurons that provide input to the cell. Thus, these observations provide a potential biophysical mechanism by which increases in response synchronization among neuronal afferents could cause the increases in neuronal responsiveness observed with attention (for further discussion of this idea, see Crick & Koch 1990, Salinas & Sejnowski 2001, Niebur et al. 2002).

Two recent studies of attention lend support to this proposal by documenting measurable changes in synchrony with attention. Steinmetz et al. (2000) recorded responses in monkey somatosensory cortex and found that the degree to which neurons fired synchronously was higher during a tactile discrimination task than during a visual discrimination task. Fries et al. (2001) found evidence of an increase in high frequency synchronization among macaque V4 neurons when attention was

directed to the stimulus within their overlapping receptive fields. Although additional experiments are needed, these studies, taken together with the dynamic clamp studies described above, suggest that response synchronization of afferent neurons may mediate the changes in response sensitivity and response gain observed with attention.

FEATURE-BASED AND OBJECT-BASED ATTENTION

Although we have primarily focused on studies of spatial attention, attention also can be directed to nonspatial features. Selectively enhancing sensitivity to a nonspatial feature may play a role in guiding attention during visual search (Wolfe et al. 1989). Although we know less about the mechanisms by which feature-based attention modulates visual responses, some similarities exist between the two types of attention that suggest they may depend on related mechanisms. Brain-imaging studies have found that directing attention to a particular feature, such as motion, causes increases in neuronal activity in areas selective for the attended feature (e.g., Beauchamp et al. 1997, Corbetta et al. 1991, O'Craven et al. 1997, Saenz et al. 2002, Saenz et al. 2003). Consistent with this finding, single-unit recording studies in the monkey have found feature-selective elevations of neuronal activity (Chelazzi et al. 1993, 1998; Haenny et al. 1988; Haenny & Schiller 1988; Maunsell et al. 1991; Motter 1994a,b; Treue & Martínez-Trujillo 1999). Chelazzi et al. (1993, 1998) recorded responses of inferotemporal cortex neurons in monkeys as they performed the task illustrated in Figure 2. They found that, unlike V4, inferotemporal neurons selective for features of the search target exhibited elevated levels of activity during the blank interval, prior to the appearance of the search array. This finding is consistent with earlier studies of delay activity in inferotemporal cortex (e.g., Fuster & Jervey 1981). As in V4 (see Figure 2) inferotemporal neurons elicited stronger responses to the search array on trials when their preferred stimulus was the target.

Feature-based attention modulates the response elicited by a single stimulus appearing in the receptive field of a V4 neuron (Motter 1994a,b). The task used in this experiment is illustrated in Figure 12A. At the beginning of each trial, the fixation point indicated the task-relevant color for that trial. Then, an array of oriented bars appeared in the visual field, half of which were of the task-relevant color, and half of which were of another color. After a delay, all but two bars, one of each color, disappeared, and the monkey had to indicate the orientation of the remaining bar that matched the color of the fixation point. Motter found that the response elicited by the bar in the receptive field during the array presentation was higher when the bar was of the task-relevant color. As illustrated in Figures 12B–D, this elevation occurred for both a preferred and a nonpreferred but excitatory stimulus, but it was more pronounced for the preferred stimulus. Figure 12B shows the population mean response when a bar of the neuron's preferred color and orientation appeared in the receptive field, and either matched (upper line, M) or did not match (lower line, NM) the cued color. Figure 12C shows comparable

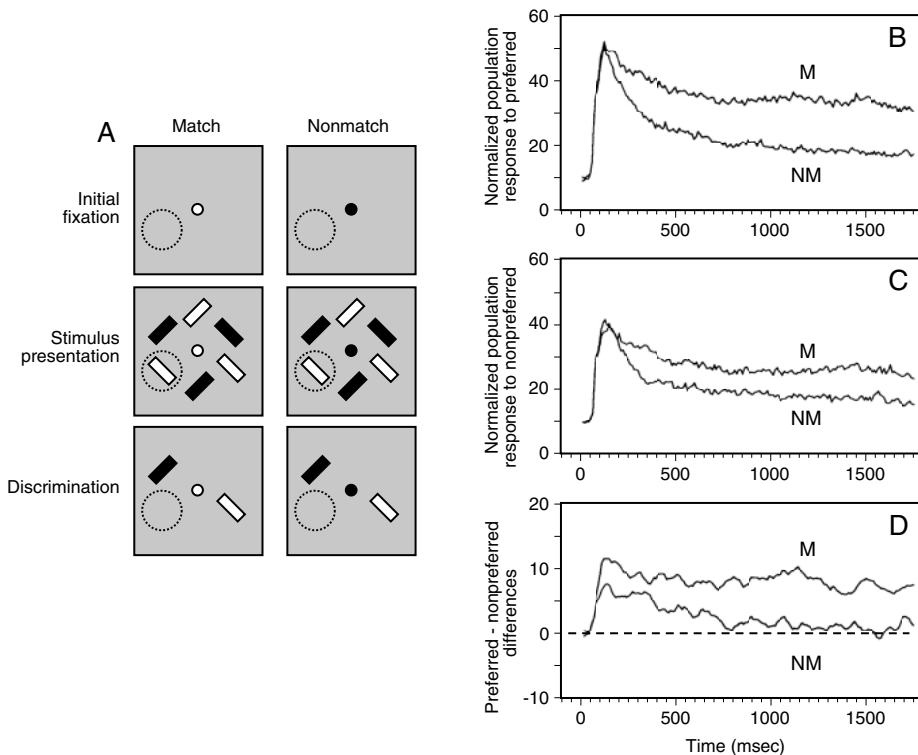

Figure 12 Feature-based attention modulates V4 neurons. (A) Task. Each trial began with a fixation point whose color indicated the color that was task relevant and thus had to be attended in that trial (“initial fixation”). An array of oriented bars appeared (stimulus presentation), a subset of which were of the task-relevant color. All but one bar of each color then disappeared, and the monkey reported the orientation of the task-relevant colored bar to earn a juice reward. (B) Population response elicited by the bar of the preferred color and orientation, when the color of the bar matched the task-relevant color (M) or did not match the task-relevant color (NM). Responses were much stronger when the bar was task relevant and was therefore attended. (C) The response elicited by stimuli that were of a nonpreferred color or orientation was also elevated when their color was attended. (D) Neurons maintained their response selectivity regardless of attention condition, as indicated by positive differences between the preferred and the poor stimulus responses.

responses when a nonpreferred stimulus appeared in the receptive field. As was true of the preferred stimulus, the response was higher when the monkey attended to the color of the stimulus in the receptive field. Neurons maintained their selectivity for the preferred and poor stimuli, regardless of which color was attended. This finding is illustrated in Figure 12D, which shows differences in the response elicited by the preferred stimulus and the poor stimulus on matching trials (upper line, M) versus nonmatching trials (lower line, NM).

Feature-based attention modulates responses throughout the visual field, even when spatial attention is directed to a particular location (Treue & Martínez-Trujillo 1999). In Treue & Martínez-Trujillo's task, a pattern of dots appeared within the receptive field of an MT neuron, moving in the neuron's preferred direction of motion, and a second pattern of dots appeared at a location in the opposite visual hemifield, moving either in the same or the opposite direction. The monkey performed a task requiring it to detect brief changes in the motion of this second stimulus. Treue & Martínez-Trujillo found that the neuron's response to the preferred stimulus in its receptive field was stronger when the monkey attended to a contralateral stimulus moving in the same, as compared to the opposite, direction. They concluded that, like spatial attention, this feature-based attention effect is multiplicative. Thus, these experiments raise the possibility that feature-based attention may operate on principles similar to those that govern spatial attention: by increasing the sensitivity of neurons to stimuli that contain the attended feature.

In addition to spatial and feature-based attention, psychophysical, imaging, and event-related-potential studies have demonstrated that attention can select whole objects. When an observer makes a judgment about one feature of an object (e.g., its color) simultaneous judgments about other features of the same object (e.g., its orientation and motion) are made efficiently and do not interfere with the first judgment (e.g., Blaser et al. 2000, Duncan 1984, Mitchell et al. 2003, Reynolds et al. 2003, Valdes-Sosa et al. 1998). This finding is considered evidence that directing attention to one feature of an object causes all of the object's features to be selected together. Consistent with this interpretation, O'Craven et al. (1999) found that discriminating one feature of an object results in increased cerebral blood flow in cortical areas that respond to the task-irrelevant features of the attended object, but not in areas that respond to features of an unattended overlapping object. Schoenfeld et al. (2003) found similar results using a combination of methods [fMRI, event-related potentials (ERPs), event-related magnetic fields (ERFs)] that enabled them to measure the time course over which attention to a task-relevant feature of an object facilitates processing of a task-irrelevant feature of the same object. In their task, observers viewed two spatially superimposed patterns of dots that moved in opposite directions, yielding the percept of two overlapping transparent surfaces. They attended to one of the surfaces to detect a change in speed. Occasionally, one of the surfaces changed color, a change that was task irrelevant. Schoenfeld and colleagues identified a region in the fusiform gyrus that showed elevated BOLD responses when this color change occurred. This area was more active when the color change took place on the attended surface than when it took place on the unattended surface. By carefully comparing the time courses of ERP/ERFs when the color change occurred on either the attended or the unattended surface, they concluded that attention to one feature of an object (here, motion) causes enhancement of other features of the same object (here, color) with a delay of 40–60 ms.

The mechanisms by which attention to one feature spreads to other features of the same object while avoiding features of unattended objects are even less well understood than are the mechanisms that modulate feature-based attention.

However, the psychophysical evidence for object-based attention is compelling, and the above imaging/ERP/ERF studies provide additional evidence that task-irrelevant features of objects are selected, even when stimuli are spatially superimposed and could not, therefore, be selected by a purely spatial attention mechanism. It will be of interest in the coming years to see whether relatively simple mechanisms like those that subserve spatial attention can be identified as neural correlates of feature-based and object-based attention.

ACKNOWLEDGMENTS

We are grateful to Matteo Carandini, Charles Connor, Jean-Marc Fellous, Ken Miller, Brad Motter, Tony Movshon, Terry Sejnowski, and David van Essen for very helpful discussions. We thank E.J. Chichilnisky, Mazyar Fallah, Garth Fowler, Greg Horwitz, Jude Mitchell, and Gene Stoner for providing critical commentary on the manuscript, and Jamie Simon for help with figures. J.R. is supported by grants from the National Eye Institute and The McKnight Endowment Fund for Neuroscience. L.C. is supported by a grant from the Human Frontier Science Program (HFSP).

The Annual Review of Neuroscience is online at <http://neuro.annualreviews.org>

LITERATURE CITED

- Albrecht DG, Geisler WS. 1991. Motion selectivity and the contrast-response function of simple cells in the visual cortex. *Vis. Neurosci.* 7:531–46
- Bashinski HS, Bacharach VR. 1980. Enhancement of perceptual sensitivity as the result of selectively attending to spatial locations. *Percept. Psychophys.* 28:241–48
- Basso MA, Wurtz RH. 1998. Modulation of neuronal activity in superior colliculus by changes in target probability. *J. Neurosci.* 18:7519–34
- Beauchamp MS, Cox RW, DeYoe EA. 1997. Graded effects of spatial and featural attention on human area MT and associated motion processing areas. *J. Neurophysiol.* 78:516–20
- Bisley JW, Goldberg ME. 2003. Neuronal activity in the lateral intraparietal area and spatial attention. *Science* 299:81–86
- Blakemore C, Tobin EA. 1972. Lateral inhibition between orientation detectors in the cat's visual cortex. *Exp. Brain Res.* 15:439–40
- Blaser E, Pylyshyn ZW, Holcombe AO. 2000. Tracking an object through feature space. *Nature* 408:196–99
- Bonds AB. 1989. Role of inhibition in the specification of orientation selectivity of cells in the cat striate cortex. *Vis. Neurosci.* 2:41–55
- Brefczynski JA, DeYoe EA. 1999. A physiological correlate of the 'spotlight' of visual attention. *Nat. Neurosci.* 2:370–74
- Britten KH, Hauer HW. 1999. Spatial summation in the receptive fields of MT neurons. *J. Neurosci.* 19(12):5074–84
- Carandini M, Heeger DJ. 1994. Summation and division by neurons in primate visual cortex. *Science* 264:1333–36
- Carandini M, Heeger DJ, Movshon JA. 1997. Linearity and normalization in simple cells of the macaque primary visual cortex. *J. Neurosci.* 17:8621–44
- Carrasco M, Penpeci-Talgar C, Eckstein M. 2000. Spatial covert attention increases contrast sensitivity across the CSF: support for signal enhancement. *Vision Res.* 40:1203–15
- Carrasco M, Ling S, Read S. 2004. Attention alters appearance. *Nat. Neurosci.* In press

- Cavanaugh JR, Bair W, Movshon JA. 2002a. Nature and interaction of signals from the receptive field center and surround in macaque V1 neurons. *J. Neurophysiol.* 88:2530–46
- Cavanaugh JR, Bair W, Movshon JA. 2002b. Selectivity and spatial distribution of signals from the receptive field surround in macaque V1 neurons. *J. Neurophysiol.* 88:2547–56
- Chance FS, Abbott LF, Reyes AD. 2002. Gain modulation from background synaptic input. *Neuron* 35:773–82
- Chelazzi L, Biscaldi M, Corbetta M, Peru A, Tassinari G, Berlucchi G. 1995. Oculomotor activity and visual spatial attention. *Behav. Brain Res.* 71:81–88
- Chelazzi L, Duncan J, Miller EK, Desimone R. 1998. Responses of neurons in inferior temporal cortex during memory-guided visual search. *J. Neurophysiol.* 80:2918–40
- Chelazzi L, Miller EK, Duncan J, Desimone R. 1993. A neural basis for visual search in inferior temporal cortex. *Nature* 363:345–47
- Chelazzi L, Miller EK, Duncan J, Desimone R. 2001. Responses of neurons in macaque area V4 during memory-guided visual search. *Cereb. Cortex* 11:761–72
- Chun MM, Marois R. 2002. The dark side of visual attention. *Curr. Opin. Neurobiol.* 12:184–89
- Colby CL, Goldberg ME. 1999. Space and attention in parietal cortex. *Annu. Rev. Neurosci.* 22:319–49
- Connor CE, Gallant JL, Preddie DC, van Essen DC. 1996. Responses in area V4 depend on the spatial relationship between stimulus and attention. *J. Neurophysiol.* 75:1306–8
- Connor CE, Preddie DC, Gallant JL, van Essen DC. 1997. Spatial attention effects in macaque area V4. *J. Neurosci.* 17:3201–14
- Cook EP, Maunsell JH. 2002. Attentional modulation of behavioral performance and neuronal responses in middle temporal and ventral intraparietal areas of macaque monkey. *J. Neurosci.* 22:1994–2004
- Corbetta M, Miezin FM, Dobmeyer S, Shulman GL, Petersen SE. 1991. Selective and divided attention during visual discriminations of shape, color, and speed: functional anatomy by positron emission tomography. *J. Neurosci.* 11:2383–402
- Corbetta M, Shulman GL. 2002. Control of goal-directed and stimulus-driven attention in the brain. *Nat. Rev. Neurosci.* 3:201–15
- Crick F, Koch C. 1990. Some reflections on visual awareness. *Cold Spring Harb. Symp. Quant. Biol.* 55:953–62
- De Weerd P, Peralta MR 3rd, Desimone R, Ungerleider LG. 1999. Loss of attentional stimulus selection after extrastriate cortical lesions in macaques. *Nat. Neurosci.* 2:753–58
- DeAngelis GC, Freeman RD, Ohzawa I. 1994. Length and width tuning of neurons in the cat's primary visual cortex. *J. Neurophysiol.* 71:347–74
- DeAngelis GC, Robson JG, Ohzawa I, Freeman RD. 1992. Organization of suppression in receptive fields of neurons in cat visual cortex. *J. Neurophysiol.* 68:144–63
- Desimone R, Duncan J. 1995. Neural mechanisms of selective visual attention. *Annu. Rev. Neurosci.* 18:193–222
- Downing CJ. 1988. Expectancy and visual-spatial attention: effects on perceptual quality. *J. Exp. Psychol. Hum. Percept. Perform.* 14:188–202
- Duncan J. 1984. Selective attention and the organization of visual information. *J. Exp. Psychol. Gen.* 113:501–17
- Duncan J, Humphreys GW. 1989. Visual search and stimulus similarity. *Psychol. Rev.* 96:433–58
- Fellous J, Rudolph M, Destexhe, Sejnowski T. 2003. Synaptic background noise controls the input/output characteristics of single cells in an in vitro model of in vivo activity. *Neuroscience* 122(3):811–29
- Ferrera VP, Lisberger SG. 1995. Attention and target selection for smooth pursuit eye movements. *J. Neurosci.* 15:7472–84
- Ferster D, Miller KD. 2000. Neural mechanisms of orientation selectivity in the visual cortex. *Annu. Rev. Neurosci.* 23:441–71

- Fitzpatrick D. 2000. Seeing beyond the receptive field in primary visual cortex. *Curr. Opin. Neurobiol.* 10:438–43
- Fries P, Reynolds JH, Rorie AE, Desimone R. 2001. Modulation of oscillatory neuronal synchronization by selective visual attention. *Science* 291:1560–63
- Fuster JM, Jervey JP. 1981. Inferotemporal neurons distinguish and retain behaviorally relevant features of visual stimuli. *Science* 212:952–55
- Gawne TJ, Martin JM. 2002. Responses of primate visual cortical V4 neurons to simultaneously presented stimuli. *J. Neurophysiol.* 88:1128–35
- Geisler W, Albrecht D. 2000. *Spatial Vision*. New York: Academic
- Gottlieb JP, Kusunoki M, Goldberg ME. 1998. The representation of visual salience in monkey parietal cortex. *Nature* 391:481–84
- Grossberg S. 1973. Contour enhancement, short-term memory, and constancies in reverberating neural networks. *Stud. App. Math* 52:217–57
- Grossberg S, Raizada RD. 2000. Contrast-sensitive perceptual grouping and object-based attention in the laminar circuits of primary visual cortex. *Vision. Res.* 40:1413–32
- Haenny PE, Maunsell JH, Schiller PH. 1988. State dependent activity in monkey visual cortex. II. Retinal and extraretinal factors in V4. *Exp. Brain Res.* 69:245–59
- Haenny PE, Schiller PH. 1988. State dependent activity in monkey visual cortex. I. Single cell activity in V1 and V4 on visual tasks. *Exp. Brain Res.* 69:225–44
- Handy TC, Kingstone A, Mangun GR. 1996. Spatial distribution of visual attention: perceptual sensitivity and response latency. *Percept. Psychophys.* 58:613–27
- Hauer HW, Britten KH. 2002. Contrast dependence of response normalization in area MT of the rhesus macaque. *J. Neurophysiol.* 88:3398–408
- Hawkins HL, Hillyard SA, Luck SJ, Mouloua M, Downing CJ, Woodward DP. 1990. Visual attention modulates signal detectability. *J. Exp. Psychol. Hum. Percept. Perform.* 16:802–11
- Heeger DJ. 1992. Normalization of cell responses in cat striate cortex. *Vis. Neurosci.* 9:181–97
- Heinze HJ, Mangun GR, Burchert W, Hinrichs H, Scholz M, et al. 1994. Combined spatial and temporal imaging of brain activity during visual selective attention in humans. *Nature* 372:543–46
- Hillyard SA, Anllo-Vento L. 1998. Event-related brain potentials in the study of visual selective attention. *Proc. Natl. Acad. Sci. USA* 95:781–87
- Hoffman JE, Subramaniam B. 1995. The role of visual attention in saccadic eye movements. *Percept. Psychophys.* 57:787–95
- Holt GR, Koch C. 1997. Shunting inhibition does not have a divisive effect on firing rates. *Neural Comput.* 9:1001–13
- Ito M, Gilbert CD. 1999. Attention modulates contextual influences in the primary visual cortex of alert monkeys. *Neuron* 22:593–604
- Itti L, Koch C. 2000. A saliency-based search mechanism for overt and covert shifts of visual attention. *Vision Res.* 40:1489–506
- James W. 1890. *The Principles of Psychology*. New York: Holt
- Kastner S, Ungerleider LG. 2000. Mechanisms of visual attention in the human cortex. *Annu. Rev. Neurosci.* 23:315–41
- Knierim JJ, van Essen DC. 1992. Neuronal responses to static texture patterns in area V1 of the alert macaque monkey. *J. Neurophysiol.* 67:961–80
- Lee DK, Itti L, Koch C, Braun J. 1999. Attention activates winner-take-all competition among visual filters. *Nat. Neurosci.* 2:375–81
- Levitt JB, Lund JS, Yoshioka T. 1996. Anatomical substrates for early stages in cortical processing of visual information in the macaque monkey. *Behav. Brain Res.* 76:5–19
- Lu ZL, Doshier BA. 1998. External noise distinguishes attention mechanisms. *Vision. Res.* 38:1183–98
- Lu ZL, Liu CQ, Doshier BA. 2000. Attention mechanisms for multi-location first- and

- second-order motion perception. *Vision Res.* 40(2):173–86
- Luck SJ, Chelazzi L, Hillyard SA, Desimone R. 1997. Neural mechanisms of spatial selective attention in areas V1, V2, and V4 of macaque visual cortex. *J. Neurophysiol.* 77:24–42
- Luck SJ, Hillyard SA, Mouloua M, Woldorff MG, Clark VP, Hawkins HL. 1994. Effects of spatial cuing on luminance detectability: psychophysical and electrophysiological evidence for early selection. *J. Exp. Psychol. Hum. Percept. Perform.* 20:887–904
- Maffei L, Fiorentini A. 1976. The unresponsive regions of visual cortical receptive fields. *Vision Res.* 16:1131–39
- Martínez-Trujillo J, Treue S. 2002. Attentional modulation strength in cortical area MT depends on stimulus contrast. *Neuron* 35:365–70
- Maunsell JH, Sclar G, Nealey TA, DePriest DD. 1991. Extraretinal representations in area V4 in the macaque monkey. *Vis. Neurosci.* 7:561–73
- McAdams CJ, Maunsell JH. 1999a. Effects of attention on orientation-tuning functions of single neurons in macaque cortical area V4. *J. Neurosci.* 19:431–41
- McAdams CJ, Maunsell JH. 1999b. Effects of attention on the reliability of individual neurons in monkey visual cortex. *Neuron* 23:765–73
- McLaughlin D, Shapley R, Shelley M, Wielaard DJ. 2000. A neuronal network model of macaque primary visual cortex (V1): orientation selectivity and dynamics in the input layer 4Calpha. *Proc. Natl. Acad. Sci. USA* 97:8087–92
- Miller EK, Gochin PM, Gross CG. 1993. Suppression of visual responses of neurons in inferior temporal cortex of the awake macaque by addition of a second stimulus. *Brain Res.* 616:25–29
- Mitchell JF, Stoner GR, Fallah M, Reynolds JH. 2003. Attentional selection of superimposed surfaces cannot be explained by modulation of the gain of color channels. *Vision Res.* 43:1323–28
- Moore T, Armstrong KM. 2003. Selective gating of visual signals by microstimulation of frontal cortex. *Nature* 421:370–73
- Moore T, Fallah M. 2001. Control of eye movements and spatial attention. *Proc. Natl. Acad. Sci. USA* 98:1273–76
- Moore T, Fallah M. 2004. Microstimulation of the frontal eye field and its effects on covert spatial attention. *J. Neurophysiol.* 91(1):152–62
- Moore T, Tolia AS, Schiller PH. 1998. Visual representations during saccadic eye movements. *Proc. Natl. Acad. Sci. USA* 95:8981–84
- Moran J, Desimone R. 1985. Selective attention gates visual processing in the extrastriate cortex. *Science* 229:782–84
- Morrone MC, Burr DC, Maffei L. 1982. Functional implications of cross-orientation inhibition of cortical visual cells. I. Neurophysiological evidence. *Proc. R. Soc. Lond. B Biol. Sci.* 216:335–54
- Motter BC. 1993. Focal attention produces spatially selective processing in visual cortical areas V1, V2, and V4 in the presence of competing stimuli. *J. Neurophysiol.* 70:909–19
- Motter BC. 1994a. Neural correlates of attentive selection for color or luminance in extrastriate area V4. *J. Neurosci.* 14:2178–89
- Motter BC. 1994b. Neural correlates of feature selective memory and pop-out in extrastriate area V4. *J. Neurosci.* 14:2190–99
- Mountcastle VB, Motter BC, Steinmetz MA, Sestokas AK. 1987. Common and differential effects of attentive fixation on the excitability of parietal and prestriate (V4) cortical visual neurons in the macaque monkey. *J. Neurosci.* 7:2239–55
- Muller HJ, Humphreys GW. 1991. Luminance-increment detection: capacity-limited or not? *J. Exp. Psychol. Hum. Percept. Perform.* 17:107–24
- Muller JR, Metha AB, Krauskopf J, Lennie P. 2003. Local signals from beyond the receptive fields of striate cortical neurons. *J. Neurophysiol.* 90:822–31
- Murphy B, Miller KD. 2003. Multiplicative gain changes are induced by excitation or

- inhibition alone. *J. Neurosci.* 23(31):10040–51
- Niebur E, Hsiao SS, Johnson KO. 2002. Synchrony: a neuronal mechanism for attentional selection? *Curr. Opin. Neurobiol.* 12:190–94
- Niebur E, Koch C. 1994. A model for the neuronal implementation of selective visual attention based on temporal correlation among neurons. *J. Comput. Neurosci.* 1:141–58
- O’Craven KM, Downing PE, Kanwisher N. 1999. fMRI evidence for objects as the units of attentional selection. *Nature* 401:584–87
- O’Craven KM, Rosen BR, Kwong KK, Treisman A, Savoy RL. 1997. Voluntary attention modulates fMRI activity in human MT-MST. *Neuron* 18:591–98
- Palmer J, Verghese P, Pavel M. 2000. The psychophysics of visual search. *Vision Res.* 40(10–12):1227–68
- Pessoa L, Kastner S, Ungerleider LG. 2003. Neuroimaging studies of attention: from modulation of sensory processing to top-down control. *J. Neurosci.* 23:3990–98
- Posner MI, Snyder CR, Davidson BJ. 1980. Attention and the detection of signals. *J. Exp. Psychol.* 109:160–74
- Qian N, Andersen RA. 1994. Transparent motion perception as detection of unbalanced motion signals. II. Physiology. *J. Neurosci.* 14:7367–80
- Recanzone GH, Wurtz RH. 2000. Effects of attention on MT and MST neuronal activity during pursuit initiation. *J. Neurophysiol.* 83:777–90
- Recanzone GH, Wurtz RH, Schwarz U. 1997. Responses of MT and MST neurons to one and two moving objects in the receptive field. *J. Neurophysiol.* 78:2904–15
- Reynolds JH, Chelazzi L, Desimone R. 1999. Competitive mechanisms subserve attention in macaque areas V2 and V4. *J. Neurosci.* 19:1736–53
- Reynolds JH, Desimone R. 2003. Interacting roles of attention and visual salience in V4. *Neuron* 37:853–63
- Reynolds JH, Pasternak T, Desimone R. 2000. Attention increases sensitivity of V4 neurons. *Neuron* 26:703–14
- Reynolds JH, Alborzian S, Stoner GR. 2003. Exogenously cued attention triggers competitive selection of surfaces. *Vision Res.* 43(1):59–66
- Robinson DA, Fuchs AF. 1969. Eye movements evoked by stimulation of frontal eye fields. *J. Neurophysiol.* 32:637–48
- Roelfsema PR, Spekreijse H. 2001. The representation of erroneously perceived stimuli in the primary visual cortex. *Neuron* 31:853–63
- Rolls ET, Tovee MJ. 1995. The responses of single neurons in the temporal visual cortical areas of the macaque when more than one stimulus is present in the receptive field. *Exp. Brain Res.* 103:409–20
- Saenz M, Buracas GT, Boynton GM. 2002. Global effects of feature-based attention in human visual cortex. *Nat. Neurosci.* 5:631–32
- Saenz M, Buracas GT, Boynton GM. 2003. Global feature-based attention for motion and color. *Vision Res.* 43:629–37
- Salinas E, Abbott LF. 1997. Invariant visual responses from attentional gain fields. *J. Neurophysiol.* 77(6):3267–72
- Salinas E, Sejnowski TJ. 2001. Correlated neuronal activity and the flow of neural information. *Nat. Rev. Neurosci.* 2:539–50
- Schall JD. 1995. Neural basis of saccade target selection. *Rev. Neurosci.* 6:63–85
- Schoenfeld MA, Tempelmann C, Martínez A, Hopf JM, Sattler C, et al. 2003. Dynamics of feature binding during object-selective attention. *Proc. Natl. Acad. Sci. USA* 100:11806–11
- Sclar G, Freeman RD. 1982. Orientation selectivity in the cat’s striate cortex is invariant with stimulus contrast. *Exp. Brain Res.* 46:457–61
- Seidemann E, Newsome WT. 1999. Effect of spatial attention on the responses of area MT neurons. *J. Neurophysiol.* 81:1783–94
- Shapley R, Hawken M, Ringach DL. 2003. Dynamics of orientation selectivity in the

- primary visual cortex and the importance of cortical inhibition. *Neuron* 38:689–99
- Sheinberg DL, Logothetis NK. 2001. Noticing familiar objects in real world scenes: the role of temporal cortical neurons in natural vision. *J. Neurosci.* 21:1340–50
- Shepherd M, Findlay JM, Hockey RJ. 1986. The relationship between eye movements and spatial attention. *Q. J. Exp. Psychol. A* 38:475–91
- Sherman SM. 2001. Thalamic relay functions. *Prog. Brain Res.* 134:51–69
- Shu Y, Hasenstaub A, Badoual M, Bal T, McCormick DA. 2003. Barrages of synaptic activity control the gain and sensitivity of cortical neurons. *J. Neurosci.* 23(32):10388–401
- Snowden RJ, Treue S, Erickson RG, Andersen RA. 1991. The response of area MT and V1 neurons to transparent motion. *J. Neurosci.* 11(9):2768–85
- Somers DC, Nelson SB, Sur M. 1995. An emergent model of orientation selectivity in cat visual cortical simple cells. *J. Neurosci.* 15:5448–65
- Somers DC, Todorov EV, Siapas AG, Toth LJ, Kim DS, Sur M. 1998. A local circuit approach to understanding integration of long-range inputs in primary visual cortex. *Cereb. Cortex* 8:204–17
- Sperling G, Sondhi MM. 1968. Model for visual luminance discrimination and flicker detection. *J. Opt. Soc. Am.* 58:1133–45
- Spitzer H, Desimone R, Moran J. 1988. Increased attention enhances both behavioral and neuronal performance. *Science* 240:338–40
- Stanton GB, Bruce CJ, Goldberg ME. 1995. Topography of projections to posterior cortical areas from the macaque frontal eye fields. *J. Comp. Neurol.* 353:291–305
- Steinmetz MA, Constantinidis C. 1995. Neurophysiological evidence for a role of posterior parietal cortex in redirecting visual attention. *Cereb. Cortex* 5:448–56
- Steinmetz PN, Roy A, Fitzgerald PJ, Hsiao SS, Johnson KO, Niebur E. 2000. Attention modulates synchronized neuronal firing in primate somatosensory cortex. *Nature* 404:187–90
- Thompson K, Bichot NP, Schall JD. 2001. From attention to action in frontal cortex. In *Visual Attention and Cortical Circuits*, ed. J Braun, C Koch, JD Davis, pp. 137–56. Cambridge, MA: MIT Press
- Treisman AM, Gelade G. 1980. A feature-integration theory of attention. *Cogn. Psychol.* 12:97–136
- Treue S. 2003. Visual attention: the where, what, how and why of saliency. *Curr. Opin. Neurobiol.* 13:428–32
- Treue S, Martínez-Trujillo JC. 1999. Feature-based attention influences motion processing gain in macaque visual cortex. *Nature* 399:575–79
- Treue S, Maunsell JH. 1996. Attentional modulation of visual motion processing in cortical areas MT and MST. *Nature* 382:539–41
- Troyer TW, Krukowski AE, Priebe NJ, Miller KD. 1998. Contrast-invariant orientation tuning in cat visual cortex: thalamocortical input tuning and correlation-based intracortical connectivity. *J. Neurosci.* 18:5908–27
- Valdes-Sosa M, Bobes MA, Rodriguez V, Pinilla T. 1998. Switching attention without shifting the spotlight object-based attentional modulation of brain potentials. *J. Cogn. Neurosci.* 10:137–51
- Vergheze P. 2001. Visual search and attention: a signal detection theory approach. *Neuron* 31(4):523–35
- Walker GA, Ohzawa I, Freeman RD. 1999. Asymmetric suppression outside the classical receptive field of the visual cortex. *J. Neurosci.* 19(23):10536–53
- Webb BS, Tinsley CJ, Barraclough NE, Parker A, Derrington AM. 2003. Gain control from beyond the classical receptive field in primate primary visual cortex. *Vis. Neurosci.* 20:221–30
- Wolfe JM, Cave KR, Franzel SL. 1989. Guided search: an alternative to the feature integration model for visual search. *J. Exp. Psychol. Hum. Percept. Perform.* 15:419–33

- Wurtz RH, Goldberg ME. 1972. The primate superior colliculus and the shift of visual attention. *Invest. Ophthalmol.* 11:441–50
- Xiao DK, Raiguel S, Marcar V, Koenderink J, Orban GA. 1995. Spatial heterogeneity of inhibitory surrounds in the middle temporal visual area. *Proc. Natl. Acad. Sci. USA* 92(24):11303–6
- Yantis S, Serences JT. 2003. Cortical mechanisms of space-based and object-based attentional control. *Curr. Opin. Neurobiol.* 13: 187–93



CONTENTS

THE AMYGDALA MODULATES THE CONSOLIDATION OF MEMORIES OF EMOTIONALLY AROUSING EXPERIENCES, <i>James L. McGaugh</i>	1
CONTROL OF CENTRAL SYNAPTIC SPECIFICITY IN INSECT SENSORY NEURONS, <i>Jonathan M. Blagburn and Jonathan P. Bacon</i>	29
SENSORY SIGNALS IN NEURAL POPULATIONS UNDERLYING TACTILE PERCEPTION AND MANIPULATION, <i>Antony W. Goodwin and Heather E. Wheat</i>	53
E PLURIBUS UNUM, EX UNO PLURA: QUANTITATIVE AND SINGLE-GENE PERSPECTIVES ON THE STUDY OF BEHAVIOR, <i>Ralph J. Greenspan</i>	79
DESENSITIZATION OF G PROTEIN-COUPLED RECEPTORS AND NEURONAL FUNCTIONS, <i>Raul R. Gainetdinov, Richard T. Premont, Laura M. Bohn, Robert J. Lefkowitz, and Marc G. Caron</i>	107
PLASTICITY OF THE SPINAL NEURAL CIRCUITRY AFTER INJURY, <i>V. Reggie Edgerton, Niranjala J.K. Tillakaratne, Allison J. Bigbee, Ray D. de Leon, and Roland R. Roy</i>	145
THE MIRROR-NEURON SYSTEM, <i>Giacomo Rizzolatti and Laila Craighero</i>	169
GENETIC APPROACHES TO THE STUDY OF ANXIETY, <i>Joshua A. Gordon and René Hen</i>	193
UBIQUITIN-DEPENDENT REGULATION OF THE SYNAPSE, <i>Aaron DiAntonio and Linda Hicke</i>	223
CELLULAR MECHANISMS OF NEURONAL POPULATION OSCILLATIONS IN THE HIPPOCAMPUS IN VITRO, <i>Roger D. Traub, Andrea Bibbig, Fiona E.N. LeBeau, Eberhard H. Buhl, and Miles A. Whittington</i>	247
THE MEDIAL TEMPORAL LOBE, <i>Larry R. Squire, Craig E.L. Stark, and Robert E. Clark</i>	279
THE NEURAL BASIS OF TEMPORAL PROCESSING, <i>Michael D. Mauk and Dean V. Buonomano</i>	307
THE NOGO SIGNALING PATHWAY FOR REGENERATION BLOCK, <i>Zhigang He and Vuk Koprivica</i>	341
MAPS IN THE BRAIN: WHAT CAN WE LEARN FROM THEM? <i>Dmitri B. Chklovskii and Alexei A. Koulakov</i>	369

ELECTRICAL SYNAPSES IN THE MAMMALIAN BRAIN, <i>Barry W. Connors and Michael A. Long</i>	393
NEURONAL CIRCUITS OF THE NEOCORTEX, <i>Rodney J. Douglas and Kevan A.C. Martin</i>	419
THE NEUROBIOLOGY OF THE ASCIDIAN TADPOLE LARVA: RECENT DEVELOPMENTS IN AN ANCIENT CHORDATE, <i>Ian A. Meinertzhagen, Patrick Lemaire, and Yasushi Okamura</i>	453
CORTICAL NEURAL PROSTHETICS, <i>Andrew B. Schwartz</i>	487
THE SYNAPTIC VESICLE CYCLE, <i>Thomas C. Südhof</i>	509
CRITICAL PERIOD REGULATION, <i>Takao K. Hensch</i>	549
CEREBELLUM-DEPENDENT LEARNING: THE ROLE OF MULTIPLE PLASTICITY MECHANISMS, <i>Edward S. Boyden, Akira Katoh, and Jennifer L. Raymond</i>	581
ATTENTIONAL MODULATION OF VISUAL PROCESSING, <i>John H. Reynolds and Leonardo Chelazzi</i>	611
THE HUMAN VISUAL CORTEX, <i>Kalanit Grill-Spector and Rafael Malach</i>	649
VISUAL MOTOR COMPUTATIONS IN INSECTS, <i>Mandyam V. Srinivasan and Shaowu Zhang</i>	679
HOW THE BRAIN PROCESSES SOCIAL INFORMATION: SEARCHING FOR THE SOCIAL BRAIN, <i>Thomas R. Insel and Russell D. Fernald</i>	697
UNRAVELING THE MECHANISMS INVOLVED IN MOTOR NEURON DEGENERATION IN ALS, <i>Lucie I. Bruijn, Timothy M. Miller, and Don W. Cleveland</i>	723
INDEXES	
Subject Index	751
Cumulative Index of Contributing Authors, Volumes 18–27	767
Cumulative Index of Chapter Titles, Volumes 18–27	772
ERRATA	
An online log of corrections to <i>Annual Review of Neuroscience</i> chapters may be found at http://neuro.annualreviews.org/	